

CELEBRATING
25 YEARS
OF TRUST &
INNOVATION



DRAINPRO™

SWR DRAINAGE REDEFINED!

*ADVANCED PP SWR SYSTEM WITH
THREE LAYERS TECHNOLOGY*



**MADE
WITH GERMAN
TECHNOLOGY**



CONTENTS

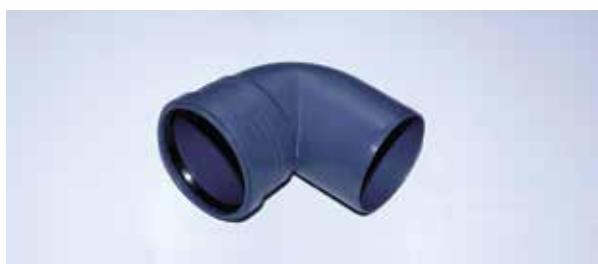

03

ABOUT ASTRAL

04

INNOVATION &
RECOGNITIONS

05

MARKETING
NETWORK

06

WARRANTY

07

SYSTEM
DESCRIPTION

08

FIELDS OF
APPLICATION

10

PIPE
STRUCTURE

11

KEY
PROPERTIES

12

SOUND INSULATION
BY ASTRAL DRAINPPRO

14

COMPARISON WITH
PVC PIPES

15

FIRE BEHAVIOUR
CLASSIFICATION

16

FIRE RESISTANCE
CLASSIFICATION

17

TYPES OF
INSTALLATION

18

PIPE
SPECIFICATIONS

19

SOCKET
DIMENSION,
PROPERTY CHART

20

PRODUCT RANGE

29

INSTALLATION
PROCEDURE

30

FIXATION

32

ARRANGEMENTS
OF THE BRACKETS

33

SUPPORT SPACING
DISTANCES

35

OUTDOOR EXPOSURE,
SPECIAL FITTINGS

36

CHEMICAL
RESISTANCE CHART

**1st TO
INTRODUCE
CPVC
IN INDIA**

**1st TO
INTRODUCE
UPVC LEAD
FREE PIPES
IN INDIA**

**1st TO
INTRODUCE
LOW NOISE
PP DRAINAGE
PIPES IN INDIA**

**1st TO
INTRODUCE
FOAMED PVC
DRAINAGE
PIPES IN INDIA**

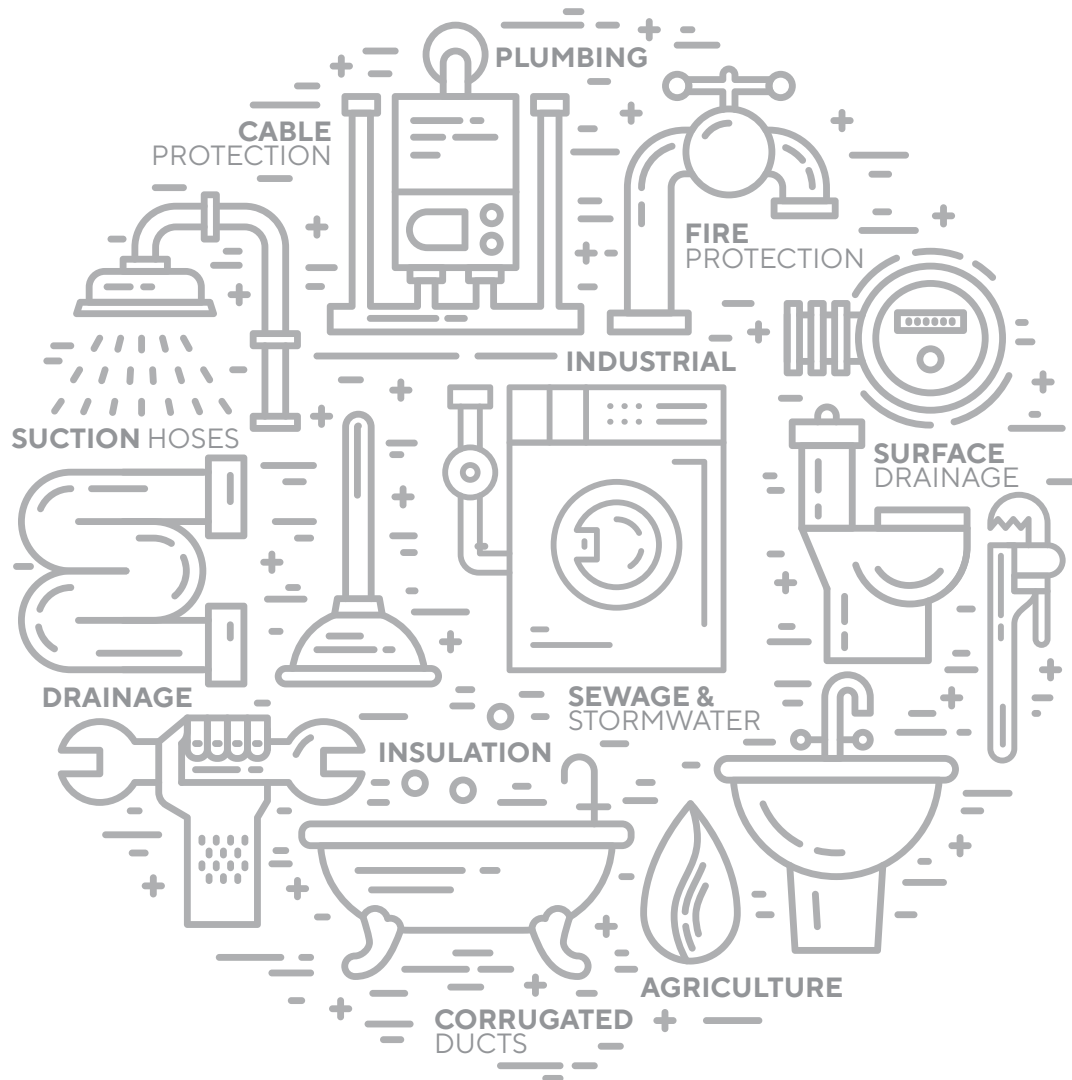

**1st TO
INTRODUCE
LEAD FREE
COLUMN PIPES
IN INDIA**

**1st TO
INTRODUCE
POLYMER BASED
INDUSTRIAL
PIPING SYSTEM
IN INDIA**

**1st TO
INTRODUCE
NSF APPROVED
SOLVENT
CEMENT
IN INDIA**

**1st TO
INTRODUCE
CPVC PIPING FOR
AUTOMATIC
FIRE SPRINKLER
SYSTEM IN INDIA**

ASTRAL, INDIA'S PROGRESSIVE BUILDING MATERIALS COMPANY

Established in 1996 with the aim to manufacture best-in-globe plastic piping systems, Astral Pipes fulfils emerging piping needs of millions of houses and adds extra mileage to India's developing real estate fraternity with the hallmark of unbeaten quality and innovative piping solutions. Keeping itself ahead of the technology curve, Astral has always been a front runner in the piping category by bringing innovation and getting rid of old, primitive and ineffective plumbing methods. Bringing CPVC in India, and pioneering in this technology, have set Astral apart and its highest quality enabled it to obtain NSF approval for its CPVC pipes and fittings. Astral went beyond the category codes by launching many industry firsts, like launching India's first lead-free uPVC pipes for plumbing as well as for stream water, just to name a few.

Astral Pipes offers the widest product range across this category when it comes to product applications. Astral Pipes is equipped with production facilities at Santej and Dholka in Gujarat, Hosur in Tamil Nadu, Ghiloth in Rajasthan, Sangli & Aurangabad in Maharashtra, Cuttack in Odisha and Sitarganj in Uttarakhand to manufacture plumbing systems, drainage systems, agriculture systems, fire sprinkler piping systems, industrial piping and electrical conduit pipes with all kinds of necessary fittings.

Astral Pipes' Infrastructure division offers a comprehensive product range including corrugated piping for drainage and cables, polyolefin cable channels, sewage treatment plants, plastic sheathing ducts, suction hoses, and sub-surface drainage systems. This range helps Astral to establish a strong foothold in infrastructure and agriculture sector in the constantly evolving business of piping.

In 2014, Astral forayed into the adhesives category by acquiring UK-based Seal It Services Ltd. and Kanpur based Resinova Chemie Ltd., which manufacture adhesives, sealants and construction chemicals. With five manufacturing facilities now in this business segment, Astral has strengthened its presence in the category and made rapid inroads.

In the year 2020, Astral has expanded its product portfolio and entered into the Water Tanks Segment. The water tank segment is an expanded domain of plumbing and water supply with a huge nationwide potential. Astral Pipes manufactures water tanks from its Santej, Aurangabad, Cuttack, Hosur & Ghiloth manufacturing facilities. A wide range of water storage tanks has helped Astral to become a versatile player in the industry.

Extending the product portfolio further, in the year 2022 Astral forayed into the categories of Faucets and Sanitaryware, followed by acquisition of Bangalore based Gem Paints to enter in the Paints category. This expansion will help Astral march firmly towards becoming a holistic building materials company.

ADHESIVES

EPOXY ADHESIVES & PUTTY
SILICONE SEALANTS
CONSTRUCTION CHEMICALS **PVA**
CYANOACRYLATE **SOLVENT CEMENTS**
TAPES **POLYMERIC FILLING COMPOUND**
ANAEROBIC ADHESIVES
INDUSTRIAL ADHESIVES
INSTANT HAND SANITIZER
SURFACE CLEANING PRODUCTS

PIPING

PLUMBING PIPES & FITTINGS
CPVC, PVC & PEX
SEWERAGE DRAINAGE PIPES & FITTINGS
AGRICULTURE PIPES & FITTINGS
INDUSTRIAL PIPES & FITTINGS
FIRE SPRINKLERS PIPES & FITTINGS
CONDUIT & CABLE PROTECTION
ANCILLARY PRODUCTS
URBAN INFRASTRUCTURE

WATER TANKS

PAINTS

DUCTING

FAUCETS

SANITARYWARE





INNOVATION & RECOGNITIONS

- First to introduce CPVC piping system in India (1999)
- First to launch lead free uPVC piping system in India (2004)
- Corp Excel- National SME Excellence Award (2006)
- First to get NSF Certification for CPVC piping system in India (2007)
- First to launch lead-free uPVC column pipes in India (2012)
- Enterprising Entrepreneur of the year (2012-13)
- Business Standard Star SME of the year (2013)
- Inc. India Innovative 100 for Smart Innovation under category of 'Technology' (2013)
- India's Most Promising Brand Award (2014)
- Value Creator Award during the first ever Fortune India Next 500 (2015)
- India's Most Trusted Pipe Brand Award (2016, 2019, 2020 & 2022)
- ET Inspiring Business Leaders of India Award (2016)
- Fortune India 500 Company (2016)
- India's Most Desired Pipe Brand Award (2022)
- Consumer Validated Superbrands India (2017, 2019 & 2021-2022)



MARKETING NETWORK

Astral has a marketing network of more than 800 distributors and 30,000 dealers spread all over India with branch offices at Mumbai, Pune, Delhi, Bengaluru, Chennai, Hyderabad, Jaipur, Lucknow and Kochi. Apart from that Astral has its own warehouses at Vijaywada, Hyderabad, Delhi, Kolhapur, Kolkata, Nagpur, Indore, Patna, Varanasi, Jaipur & Hosur to deliver the material as quick as possible. More than 400 techno marketing professionals and administrative personnel are on the board to coordinate with architects, plumbing contractors and plumbers to utilize the best plumbing techniques and to get the best from the products.

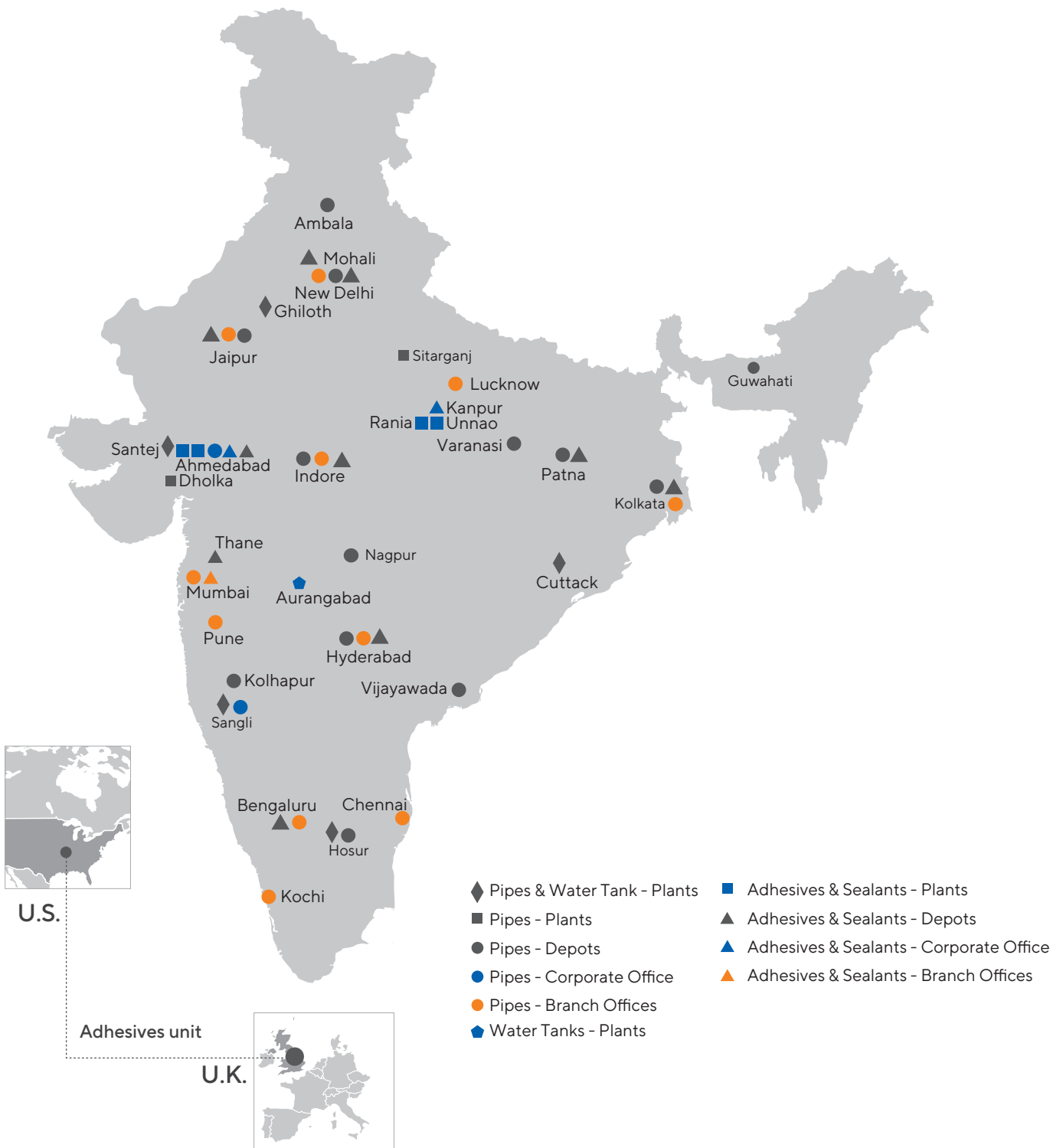

WARRANTY

VALID FOR THE FOLLOWING AREAS OF APPLICATION:

- Noise-insulated above-ground drainage
- Highly noise-insulated above-ground drainage

In addition to any legal warranty and damage claims, upon the agreement of Astral Pipes general terms of business, the company undertakes the following:

WARRANTY:

Astral Ltd. hereby warrants the performance of its high-quality DrainPro Piping system. The warranty period shall extend up to 10 years from the date of manufacture for all the standard elements mentioned in this catalogue.

THIS LIABILITY ENCOMPASSES:

1. Free delivery to the place of employment of the replacement parts required for the repair of the damage.
2. Necessary removal and installation costs, including the expenses incurred for the restoration of the object to its original condition, up to a sum of USD 25000.

Pursuant to this declaration Astral provides this Warranty when,

1. Laying was completed by trained personnel from a licensed sanitary plumbing company in connection with installation as contractually intended and all the technical regulations valid at the time of completion were observed.
2. Only Astral original parts were employed and that these were not combined with products of any other origin.
3. The cause of damage did not relate to parts subject to natural wear and tear, external mechanical damage, or other external influences on the product.
4. It can be proven that at the time of laying all the current storage, laying, installation and application stipulations were observed in full.
5. All the measures necessary for damage minimization were initiated immediately.
6. The occurrence of damage was reported to Astral without delay and under all circumstances within 10 days of the identification of the damage, complete with information concerning the related facts and circumstances.
7. Prior to repair work, Astral is given an opportunity to determine and appraise the damage itself or through a third party.
8. All the parts relating to the claim are kept for the investigation of the damage occurrence and are provided to Astral upon request.
9. The production and installation dates can be evidenced in the appropriate form.



SYSTEM DESCRIPTION

Astral DrainPro is unique piping system manufactured using PP mineral filled materials and designed to cater most challenging drainage and sewerage applications. The system is perfect replacement of conventional system by overcoming the limitations encountered while using such traditional piping systems. Astral DrainPro offers superior piping experience in all aspects – be it Mechanical, Thermal, Chemical or Acoustic properties compare to such traditional systems. The system has high temperature resistance (long term 90°C & short term 95°C) and excellent chemical resistance (pH 2 to pH 12) over broader range of chemicals.

Astral DrainPro has an extensive range of pipes and fittings ranging from 40mm to 160mm including extensive range of fittings and accessories which makes it ideal choice of drainage and sewerage system for building industry. There are many specialized fittings like 75mm water seal traps with height risers – available in different combinations – gives enormous design opportunities to specifier and designers. The push fit system is universally accepted and can be easily used with different trade solution.

THE RAW MATERIAL

Astral DrainPro's mineral filled Polypropylene (PP) compound has been thoughtfully curated with minimum molecular density of 1.4gm/cc to give incredible Acoustic and Mechanical properties. Our compound offers prevalent ring stiffness and impact obstruction which are fundamental for any drainage and sewerage piping framework. Along with these remarkable properties, Astral DrainPro performs adequately when exposed to various chemicals and hot water. The unique compound prevents scaling, incrustation and corrosion throughout the lifespan.



FIELDS OF APPLICATION

The sound-insulating Astral DrainPro is suitable for gravity drainage system as laid down in DIN EN 12056 (Gravity Drainage Systems Inside Buildings-Sanitary Pipework, Layout and Calculation) and DIN 1986-100 (Drainage System on Private Ground). India's national standards, code of practice and regulations must be followed during the design and installation of Astral DrainPro drainage system. The pipes, fittings and seals can operate continuously at 90°C / 194°F (95°C/203°F Intermittently). They are suitable for the drainage of chemically aggressive wastewater with pH value of 2 (acidic) to 12 (basic). Fire resistance of Astral DrainPro corresponds to B2 normal combustibility according to DIN 4102 (Fire behaviour of Building Materials & Building Components-Building materials, concepts, requirements and tests) and D - s2, d0 according to EN 13501-1 (Fire classification of construction products and building elements- classification using data from reaction to fire tests). The pipe connections are leak-proof up to an internal excess water pressure of 0.5 bar (5 m /16.4 feet) water column. The possible usage of Astral DrainPro is shown in the following figure:

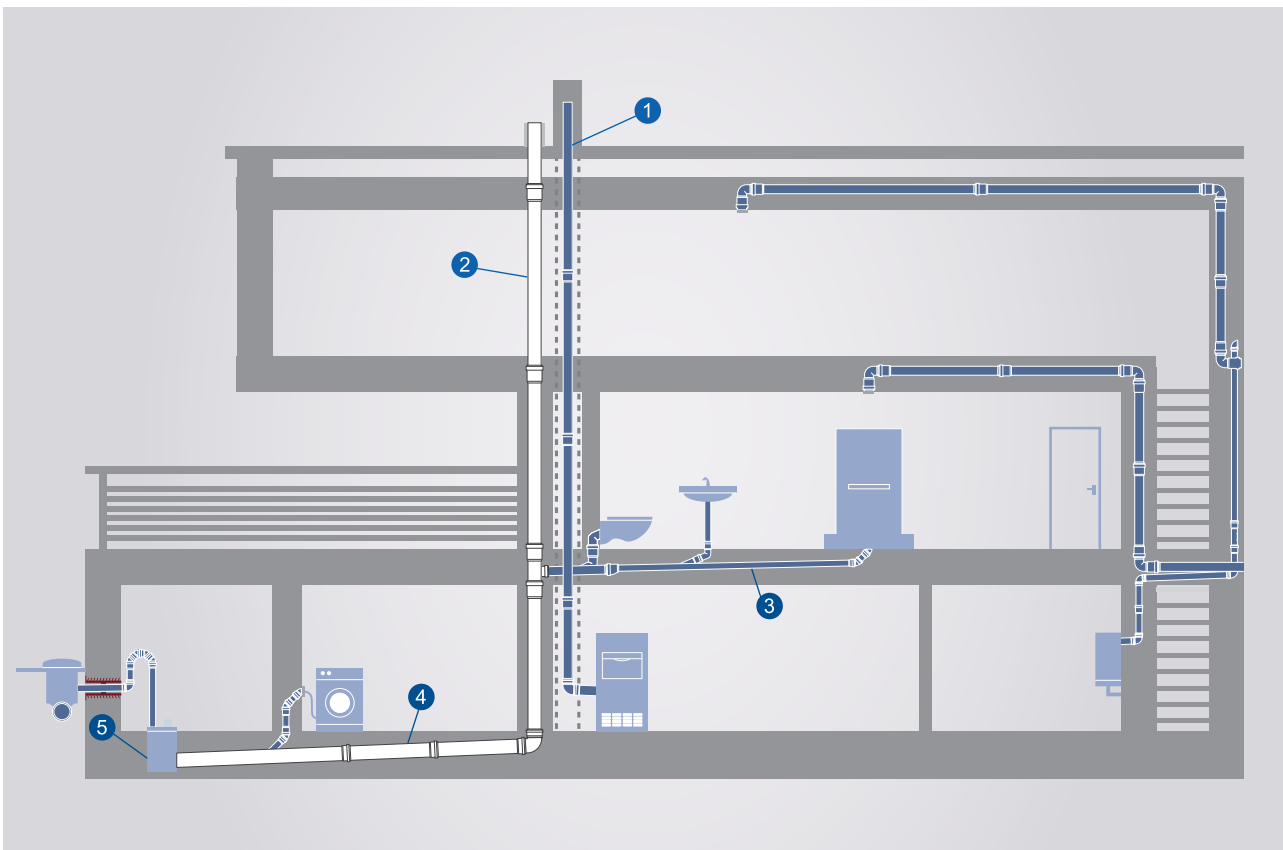

1. RAIN STACK PIPE, 2. SOIL PIPE, 3. WASTE DRAIN PIPE, 4. UNDERGROUND PIPE TO INSPECTION CHAMBER, 5. INSPECTION CHAMBER

COMMERCIAL KITCHENS



Astral DrainPro piping system can resist extreme temperature conditions including high and low temperatures. Astral DrainPro system can withstand up to 95°C for a short term exposure and upto 90°C for a long term exposure. This makes the system ideal for the commercial kitchens & trade waste applications

RESIDENTIAL BUILDINGS



Mineral filled Polypropylene material keeps system shock and vibration proof. This special characteristic helps to reduce noise during waste discharge. The 3 layer pipe construction and PP mineral filled material of DrainPro provides good sound insulation properties.

CHEMICAL LABS



Drainage and sewerage piping systems often encounter extreme challenging conditions due to the usage of various types of chemicals and waste water. Astral DrainPro piping has excellent resistance to such chemicals and keeps the system away from corrosion, rusting and pitting. Due to Poly Propylene material it can be used for a wide variety of chemicals ranging from pH2 to pH12. This makes the DrainPro piping system the ideal choice for laboratory discharge.

IMPACT STRENGTH



Semi-crystalline nature of PP imparts high impact and fatigue resistance that helps Astral DrainPro to overcome many challenges of a traditional system like breakages and damages due to transportation, handling and storage of pipes on site.

ABRASION RESISTANCE



The smooth and abrasion-resistant inner surface enables obstacle-free flow by keeping the inner surface free from deposits and scaling.

ECO-FRIENDLY



The manufacturing and installation processes of Astral DrainPro piping system utilises very less energy and its 100% recyclable material makes the system an eco-friendly solution.

PIPE STRUCTURE

DrainPro pipes are manufactured using state of the art multilayer piping technology which imparts excellent properties to pipes which are very essential to have a superior performance of the drainage systems.

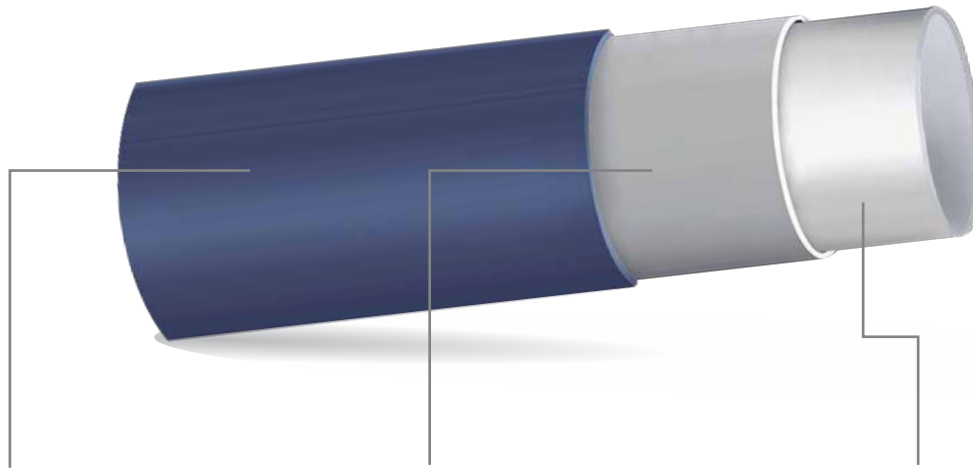

Outer Layer - Manufactured using PP material - impact - resistance and UV resistance

Middle Layer - Manufactured using mineral reinforced PP material - imparts rigidity and acoustic performance; and

Inner Layer - Manufactured using PP material - imparts smooth flow and abrasion resistance

FITTINGS & FEATURES

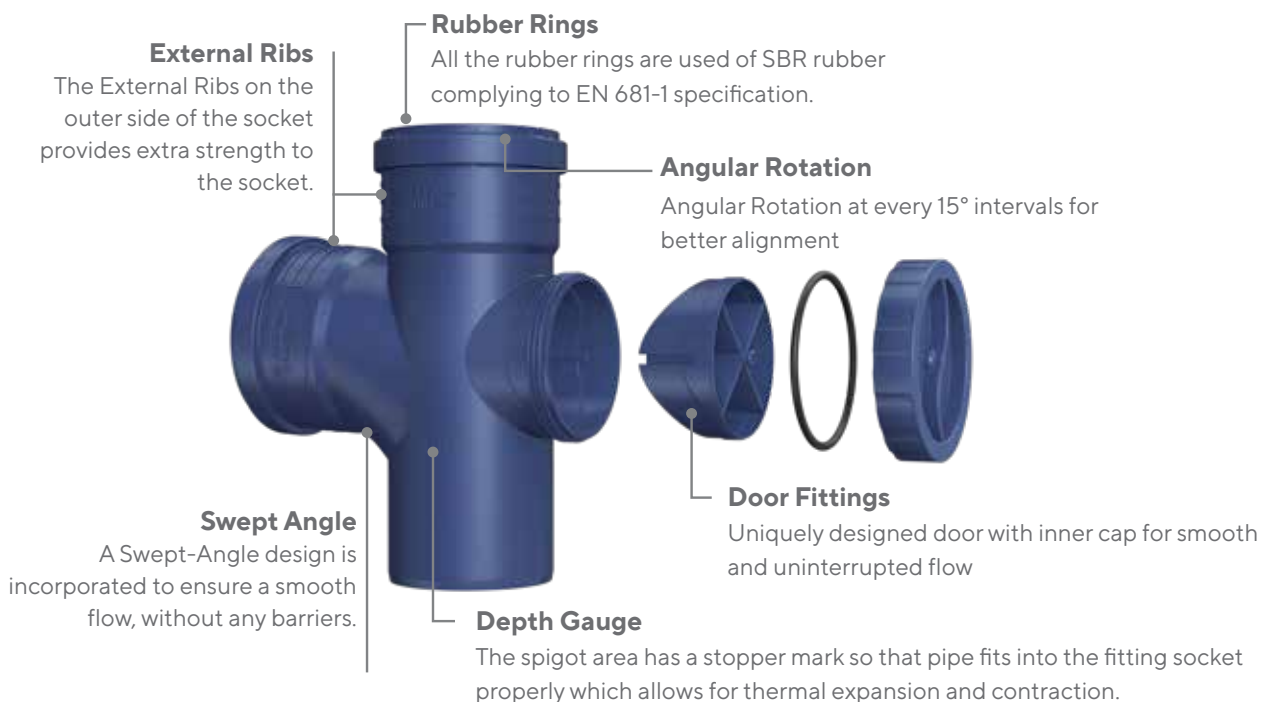

KEY PROPERTIES



HIGH IMPACT STRENGTH AND FATIGUE RESISTANCE

Semi-crystalline nature of Polypropylene imparts high impact resistance and fatigue resistance. Astral DrainPro has very high impact resistance and can resolve many current issues of traditional system like breakages and damages occurred due to transportation, handling and storage of pipes on site.



SMOOTH AND ABRASION RESISTANT INNER SURFACE

The smooth and abrasion-resistant inner surface ensures that pipes remain free from deposits and scaling due to which flow rate will remain high and maintained.



ECO-FRIENDLY

As very less energy is being utilized to manufacture piping system components and installation, Astral DrainPro is an eco-friendly solution which will not harm the Environment as it minimizes the usage of natural resources like energy and water. Further, the material is also 100% recyclable after its service life making it an even greener choice.



UV STABILITY AND LONG LIFE

DrainPro piping is manufactured using UV Stabilized material which protects the pipes and fittings from the degradative attack of UV energy which thus improves the lifespan of the product.



LOWER THERMAL EXPANSION

Special 3-layer PP material construction with middle layer of mineral reinforced polypropylene makes Astral DrainPro system a highly recommended system when the thermal changes are more due to external and internal temperature changes. The thermal expansion of DrainPro is almost half than that of the HDPE material. Also, the push fit connection system makes it more versatile and a stable system during such changes in length due to expansion and contraction.



SIMPLE AND QUICK JOINING

Unique joining of pipe and fittings with push fit rubber ring joining system provides leak-proof solution for waste-water discharge. Even replacement and transfer of piping is very easy without cutting the pipe.



LOWER COST

Push fit rubber joining provides easy installation which saves time & helps to reduce human efforts. Also, due to its light weight, the cost involved in transportation, handling and installation is low. Such benefits are more prominent against usage of heavy metallic piping systems.



SHOCK AND VIBRATION PROOF

Rigid structures are more prone to breakage due to vibrations. Additional flexibility is given to the drainage piping system by not gluing or welding the joints. The characteristic feature of push fit system of DrainPro provides not only air-tight and leak-proof connection but also a shock and vibration resistant joint. This can help to maintain pipe integrity in the event of an earthquake.

SOUND INSULATION BY ASTRAL DRAINPRO

3-layer pipe construction and PP mineral filled material of DrainPro provides good sound insulation properties as compared to a conventional PVC-piping system. It has 1.4 gm/cc density, such properties of the system which enables Astral DrainPro to absorb air-borne sound as well as mechanical vibrations.

The measurements in this test were performed following German standard DIN EN14366 (Laboratory measurement of noise from waste-water installations) and DIN 4109 (Sound insulation in Buildings-Minimum requirements); noise excitation by stationary water flow with 0.5 l/s, 1.0 l/s, 2.0 l/s, 3.0 l/s and 4.0 l/s.

In order to precisely determine real noise emission of the pipe system in a room, it requires a more dynamic test setup.

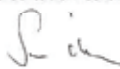
Determination of the Acoustic Performance of a Wastewater Installation System in the Laboratory according to DIN EN 14366		P-BA 106/2022e																																														
		Results sheet 1																																														
Client:	ASTRAL LIMITED, AHMEDABAD – 380 059, India																																															
Test specimen:	Wastewater system made of plastic, type: "ASTRAL DRAINPRO™" (manufacturer: Astral Limited); consisting of straight pipes and fittings (OD 110) as well as acoustic pipe clamps with elastic inlay, type: "BISMAT® 1000" (manufacturer: Walraven GmbH); test object S 11862-05; see figure 4 and 5.																																															
Test set-up:	<ul style="list-style-type: none"> The pipe system was mounted according to figure 4 and 5 (see also Annex A). The pipe system consisted of straight wastewater pipes (nominal size OD 110), three inlet tees (~88°, rounded), a 2 x 45° basement bend and a horizontal drain section. Lids supplied by the manufacturer closed the inlet tees in the basement and in the ground floor. Pipe system: type: "ASTRAL DRAINPRO™, Advanced PP-SWR System; DN 110x3.5 mm; 202202250391"; three layer pipes with shaped pipe sockets, material: PP/PP-MD/PP, wall thickness: 3.7 mm, weight: 1.72 kg/m, density: 1.41 g/cm³. One-layer fittings, material: PP-MD, wall thickness: 4.0 mm, density: 1.45 g/cm³, above-mentioned values measured by IBP; manufacturer information: density (pipe + fitting): 1.4 g/cm³, pipe wall thickness: min. 3.4 mm. Plug connection of the pipes and fittings (shaped pipe sockets). Pipe clamps: Acoustic pipe clamps, type: "BISMAT® 1000" (manufacturer: Walraven GmbH); structure-borne sound insulating support attachment consisting of BISMAT® SL loose clamps and BISMAT® SX socket clamps fixed to the installation wall with an adjustable wall plate with dowels and thread rods. In every storcy (EG and UG) respectively two clamps were installed. At the upper wall area one loose clamp (SL, DN 100) was mounted. At the lower wall area one double clamp consisting of supporting clamp (SL, DN 100) and fixing clamp (SX, DN 100) was installed (figure 5). To prevent contact to the pipe, the loose clamp (SL) was mounted with 15 mm space between the locking tabs of the clamp (two 7.5 mm spacers on each side). The clamps were closed with a tightening torque of 2 Nm. The wastewater installation system was mounted by a technician under the authority of Fraunhofer IBP. 																																															
Test facility:	Installation test facility P12, mass per unit area of the installation wall: 220 kg/m², mass per unit area of the ceiling: 440 kg/m². Installation rooms: sub-basement (KG), basement (UG) front, ground floor (EG) front and top floor (DG), measuring rooms: UG front, UG rear (details in Annex P and DIN EN 14366:2020-02).																																															
Test method:	The measurements were performed according to DIN EN 14366:2020-02; noise excitation by steady water flow with 0.5 l/s, 1.0 l/s, 2.0 l/s and 4.0 l/s. Additional evaluation for comparison with requirements following German standards DIN 4109:2018-01 and VDI 4100:2012-10 (details in Annexes A, F and V).																																															
Result:	<table border="1"> <thead> <tr> <th rowspan="2">Test specimen: Wastewater system made of plastic, type: "ASTRAL DRAINPRO™" (manufacturer: Astral Limited); consisting of straight pipes and fittings (OD 110) as well as acoustic pipe clamps with elastic inlay, type: "BISMAT® 1000" (manufacturer: Walraven GmbH).</th> <th colspan="4">Flow rate [l/s]</th> </tr> <tr> <th>0.5</th> <th>1.0</th> <th>2.0</th> <th>4.0</th> </tr> </thead> <tbody> <tr> <td>Airborne sound pressure level $L_{p,A}$ [dB(A)] according to DIN EN 14366 for the basement test-room</td> <td>UG front</td> <td>42</td> <td>46</td> <td>49</td> <td>52</td> </tr> <tr> <td>Structure-borne sound characteristic level $L_{s,c,A}$ [dB(A)] according to DIN EN 14366 for the basement test-room</td> <td>UG rear</td> <td><10</td> <td><10</td> <td>13</td> <td>17</td> </tr> <tr> <td rowspan="2">Installation sound level $L_{A,req,1}$ [dB(A)] following DIN 4109 in the basement test-room</td> <td>UG front</td> <td>42</td> <td>46</td> <td>49</td> <td>52</td> </tr> <tr> <td>UG rear</td> <td><10</td> <td>10</td> <td>15</td> <td>19</td> </tr> <tr> <td rowspan="2">Installation sound level $L_{A,req,10}$ [dB(A)] following VDI 4100 in the basement test-room</td> <td>UG front</td> <td>39</td> <td>44</td> <td>47</td> <td>50</td> </tr> <tr> <td>UG rear</td> <td><10</td> <td><10</td> <td>12</td> <td>16</td> </tr> </tbody> </table>					Test specimen: Wastewater system made of plastic, type: "ASTRAL DRAINPRO™" (manufacturer: Astral Limited); consisting of straight pipes and fittings (OD 110) as well as acoustic pipe clamps with elastic inlay, type: "BISMAT® 1000" (manufacturer: Walraven GmbH).	Flow rate [l/s]				0.5	1.0	2.0	4.0	Airborne sound pressure level $L_{p,A}$ [dB(A)] according to DIN EN 14366 for the basement test-room	UG front	42	46	49	52	Structure-borne sound characteristic level $L_{s,c,A}$ [dB(A)] according to DIN EN 14366 for the basement test-room	UG rear	<10	<10	13	17	Installation sound level $L_{A,req,1}$ [dB(A)] following DIN 4109 in the basement test-room	UG front	42	46	49	52	UG rear	<10	10	15	19	Installation sound level $L_{A,req,10}$ [dB(A)] following VDI 4100 in the basement test-room	UG front	39	44	47	50	UG rear	<10	<10	12	16
Test specimen: Wastewater system made of plastic, type: "ASTRAL DRAINPRO™" (manufacturer: Astral Limited); consisting of straight pipes and fittings (OD 110) as well as acoustic pipe clamps with elastic inlay, type: "BISMAT® 1000" (manufacturer: Walraven GmbH).	Flow rate [l/s]																																															
	0.5	1.0	2.0	4.0																																												
Airborne sound pressure level $L_{p,A}$ [dB(A)] according to DIN EN 14366 for the basement test-room	UG front	42	46	49	52																																											
Structure-borne sound characteristic level $L_{s,c,A}$ [dB(A)] according to DIN EN 14366 for the basement test-room	UG rear	<10	<10	13	17																																											
Installation sound level $L_{A,req,1}$ [dB(A)] following DIN 4109 in the basement test-room	UG front	42	46	49	52																																											
	UG rear	<10	10	15	19																																											
Installation sound level $L_{A,req,10}$ [dB(A)] following VDI 4100 in the basement test-room	UG front	39	44	47	50																																											
	UG rear	<10	<10	12	16																																											
Test date:	April 26, 2022																																															
Notes:	<ul style="list-style-type: none"> - For comparing test results with requirements according to DIN 4109 and VDI 4100 note Annex A. - The above-mentioned measurement results require careful assembly of the pipe clamps (see test set-up). - Sound levels below 10 dB(A) are not mentioned in the official test report, since they are subject to an increased measurement uncertainty and moreover are not noticeable in a normal living environment. 																																															
		The test was carried out in a laboratory, accredited according to DIN EN ISO/IEC 17025:2018 by DAkkS. The accreditation certificate is D-PL-11140-11-01. Stuttgart, July 14, 2022 Head of Laboratory: 																																														

Representation of the test object, measurement setup

P-BA 106/2022e

Client: ASTRAL LIMITED, AHMEDABAD – 380 059, India

figure 4

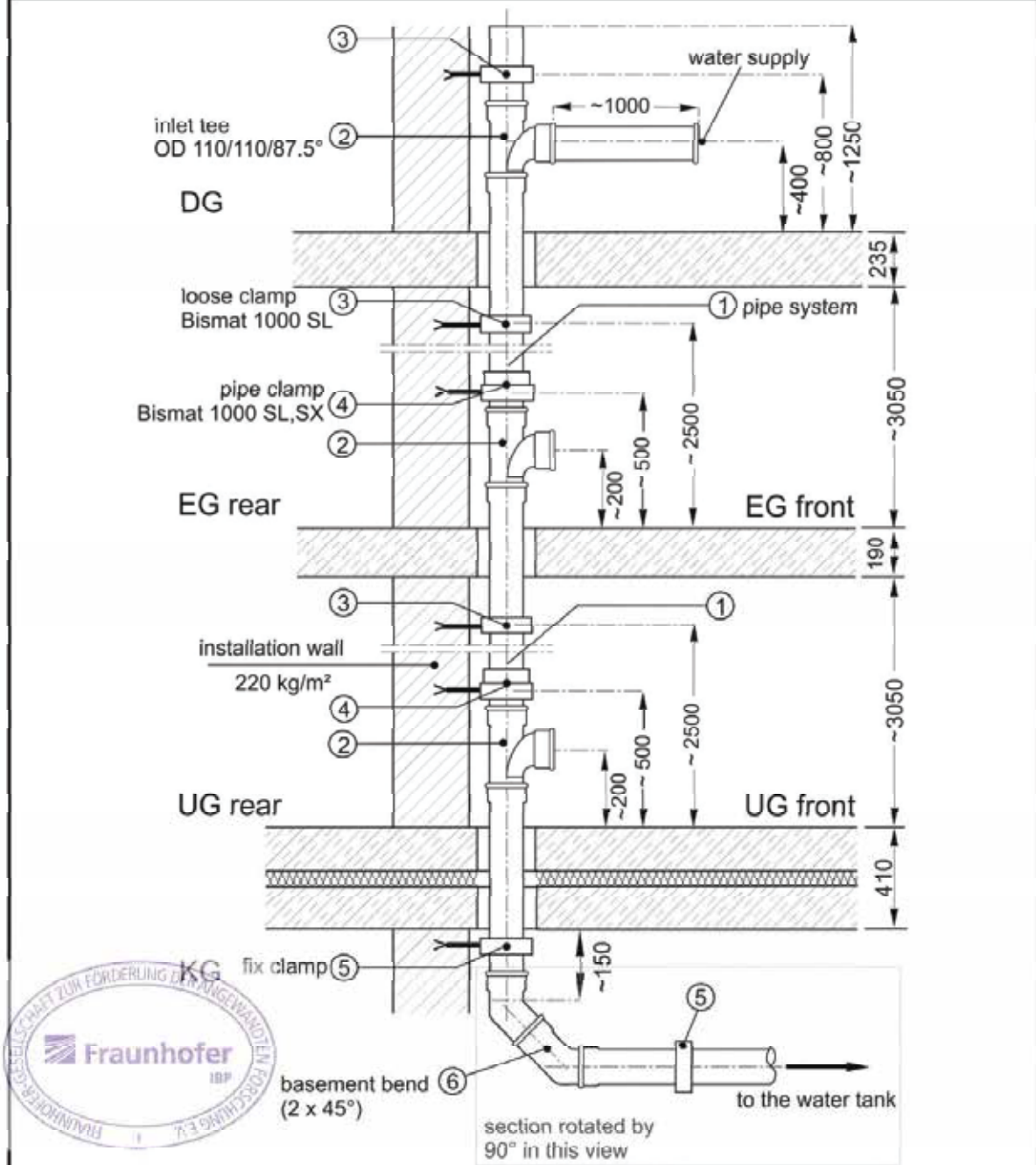

Installation plan of the test set-up in the test facility. Illustration simplified, schematically drawn and not to scale.

Test specimen: Wastewater system made of plastic, type: "ASTRAL DRAINPRO™" (manufacturer: Astral Limited); consisting of straight pipes and fittings (OD 110) as well as acoustic pipe clamps with elastic inlay, type: "BISMAT® 1000" (manufacturer: Walraven GmbH). In every storey (EG and UG) respectively two clamps were installed. At the upper wall area one loose clamp (SL, DN 100) was mounted. At the lower wall area one double clamp consisting of supporting clamp (SL, DN 100) and fixing clamp (SX, DN 100) was installed (figure 5). To prevent contact to the pipe, the loose clamp (SL) was mounted with 15 mm space between the locking tabs of the clamp (two 7.5 mm spacers on each side). Further information on the test setup can be found in the results sheet 1 as well as figure 5.

UPGRADE TO ASTRAL DRAINPRO

FEATURES	3-LAYER DRAINPRO PIPES	PVC/DWV PIPES
MATERIAL PROPERTY	▶ PP is flexible and tough	▶ PVC is Hard and Brittle
IMPACT STRENGTH	▶ 2x impact strength than PVC	▶ Low impact strength, prone to damages in handling
CHEMICAL RESISTANCE	▶ Exceptional chemical resistance withstands wide range of chemicals ranging from pH 2 to pH 12	▶ Limited chemical resistance
TEMPERATURE RESISTANCE	▶ Can work up to 95°C for short exposure and 90°C for long exposure	▶ Can work up to 60°C temperature
VERSATILE	▶ Can be used in commercial kitchens, laboratories to hospitals etc	▶ Only ordinary drainage applications
SUSPENDED APPLICATION	▶ Highly suitable	▶ Limited suitability
ACOUSTIC PROPERTIES	▶ Very good sound insulation	▶ Poor Sound insulation
FITTINGS	▶ Value engineering with swept angle, depth gauge marking, angular rotation for better alignment, prefitted door assembly for use in high rise building etc.	▶ Currently no such special fittings are available in India

FIRE BEHAVIOUR CLASSIFICATION

Fire behaviour of construction materials, e.g. piping systems and isolation materials, has been defined in fire classification classes as per DIN 4102-1 (Fire behaviour of Building Materials & Building Components-Building materials, concepts, requirements and tests). Construction materials are classified as combustible and non-combustible materials. Astral DrainPro is listed as B2 non-readily ignitable as per DIN 4102-1 (Fire behaviour of Building Materials & Building Components-Building materials, concepts, requirements and tests).

Criteria	Old Classification as per DIN 4102-1	New European classification according to DIN EN 13501-1		
		Additional criteria		
Non-combustible	A1	A1		
	A2	A2	s1	d0
Non-readily ignitable (low flame spread)	B1	B	s1	d0
		C	s1	d0
		A2	s2/s3	d0
		B	s2/s3	d0
		C	s2/s3	d0
		A2	s1	d1/d2
		B	s1	d1/d2
		C	s1	d1/d2
		A2	s3	d2
Normally ignitable (normal fire behaviour)	B2	D	s1/s2/s3	d0
		E	-	d0
		D	s1/s2/s3	d2
		E	-	d2
Readily ignitable	B3	F	-	-

Fire behaviour classification according to DIN 4102-1 (Fire behaviour of Building Materials & Building Components - Building materials, concepts, requirements and tests) and DIN EN 13501-1 (Fire classification of construction products and building elements-Classification using data from reaction to fire tests).

In line with European standardization, the fire classification classes as per DIN 4102-1 (Fire behaviour of Building Materials & Building Components-Building materials, concepts, requirements and tests) are translated into the European DIN EN 13501 (Fire classification of construction products and building elements-Classification using data from reaction to fire tests). The accreditation is based on the standardized Single-Burning-Item-Test (SBI) in conformity with DIN EN 13823 (Reaction to fire tests for building products-building products excluding flooring exposed to the thermal attack by a single burning item).

FIRE RESISTANCE CLASSIFICATION

The fire resistance classification provides the fire resistance duration of a specific construction material.

Fire resistance classification	Fire resistance duration in minutes
F30	≥ 30 = fire retardant
F60	≥ 60 = high fire retardant
F90	≥ 90 = fire resistant
F120	≥ 120 = high fire resistant
F180	≥ 180 = extreme fire resistant

FIRE RESISTANCE CLASSIFICATION

Possible additions to these fire resistance classes, e.g. z.B. F90 A or F90 AB, can be explained as follows:

- A made of non-combustible materials
- B made of combustible materials
- AB in principle made of non-combustible materials

FUNCTION OF FIRE PROTECTION COLLAR

The Astral Fire Protection Collar fully seals the wall or ceiling corridor by transforming the pipe into deformable material during the event of fire or extreme heat. The fire collar is made with special fire protection material, which expands with a high degree of heat that further resists the fire. The fire collar provides fire-resistant sealing for the wall and ceiling installation of Astral DrainPro.

GENERAL RECOMMENDATIONS

(1) Positioning of the collars:

On both sides of a wall; on one side under/in a ceiling.

(2) Wall & ceiling types:

At least 10 cm / 4 Inches thick solid concrete, aerated concrete and sand-lime brick walls as well as light dividing walls (stud walls: both sides clad with 12.5 mm / 0.5 inches plasterboard) and solid concrete and aerated concrete ceilings at least 15 cm / 6 inches thick.

(3) Structural acoustic insulation:

The acoustic insulation mat provided must be wrapped around the pipe where it passes through the wall or ceiling.

(4) Joint sealing between pipe and wall/ceiling:

To be packed to the full thickness of the wall or ceiling using mineral materials such as concrete, cement or plaster.

TYPES OF INSTALLATION

CEILING INSTALLATION

Minimum requirements of the ceiling: min. 15.0 cm / 6 Inches thick concrete ceiling.

FLUSH/STRAIGHT CEILING INSTALLATION

- Wrap protecting mat around the pipe
- While hooking in the push-in fastening, open the collar and position it around the line
- Bend the collar mounting tabs
- Install the collar flush with the ceiling
- Fill the leftover ceiling gap with concrete or cement
- Hold the collar firmly against the ceiling and mark the places of the mounting holes
- Rotate the collar and drill the holes
- Insert plugs and fix the collar utilizing screws and washers. (Mounting the collar utilizing the washers, attachments, and screws given)

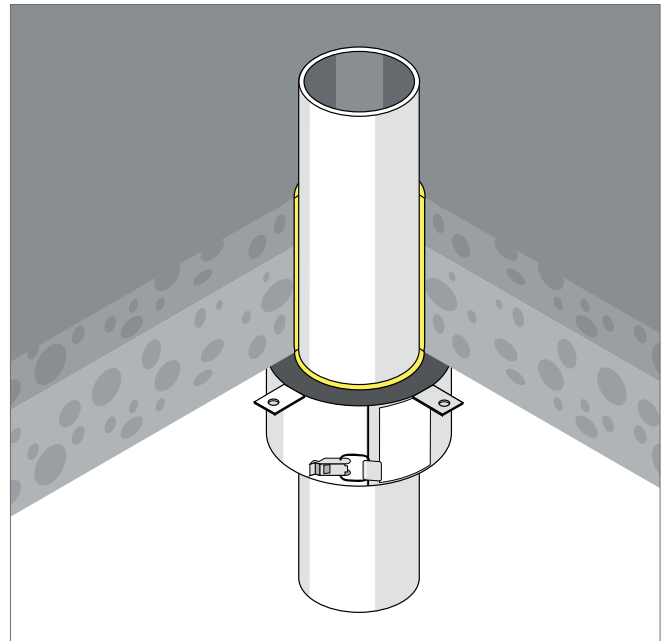

INSTALLATION OF FIREPROOFING COLLAR ON CEILING

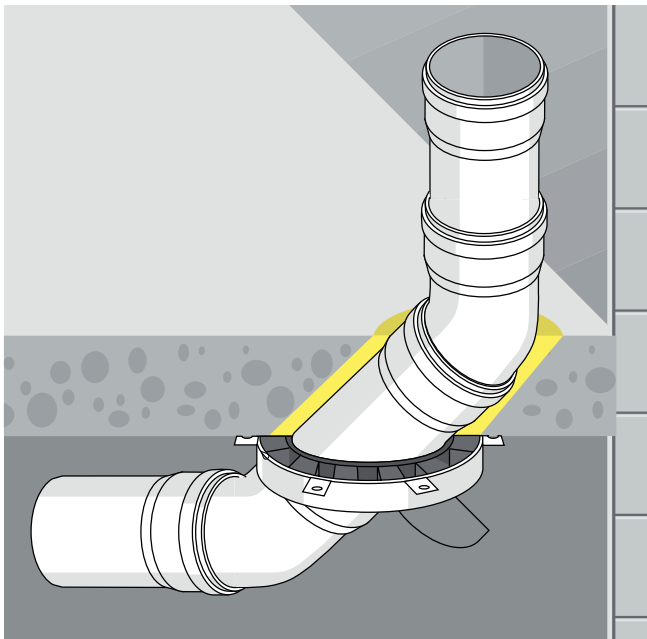

INSTALLATION OF FIREPROOFING COLLAR IN ANGLED CEILING

ANGLED CEILING INSTALLATION

- Wrap protecting mat around the pipe
- While hooking in the push-in fastening, open the collar and position it around the line Fill the leftover ceiling gap with concrete or cement
- Hold the collar firmly against the ceiling and mark the places of the mounting holes
- Rotate the collar and drill the holes
- Insert plugs and fix the collar utilizing screws and washers. (Mounting the collar utilizing the washers, attachments, and screws given)

INSTALLATION DISTANCES BETWEEN FIRE PROTECTION COLLARS E.G. TO EXTERNAL SYSTEMS

It is required that the distance between partitioned sections be at least 50 mm / 2 Inches from external partitioned systems (inspected and approved). For special partitioned sections (sloping pipes, partition via sleeve/socket or for ceiling installations) a minimum distance of 100 mm / 4 inches must be maintained between adjacent Astral feed-throughs. If the straight pipes do not have sleeves / sockets in the partition area, the collar casings can be next to each other (distance can be equal to 0 mm)

WALL INSTALLATION

Minimum wall specifications: For a lightweight partition wall, it must be made of lightweight plasterboard panels and 12.5mm / 0.5 inches of mineral wool or at least 100 mm / 4 Inches thick, made from concrete, aerated concrete, lime sandstone. When using wall feed-throughs, a collar should be fitted on both the side of the wall. A distance of 50 cm is necessary between the pipe and the clamps.

NOTE

The presented data, especially recommendations for the processing and use of our products are based on our knowledge and experience. Due to differences in material and working conditions that are outside the scope of our influence, we recommend that sufficient internal trials should be conducted in each case to ensure the suitability of our product to the intended method and processing purposes. No liability will be accepted either on the basis of these instructions or from an oral advice, unless we are accused of gross negligence or deliberate malice.

Overview of possible installation situations:

PIPE SPECIFICATIONS

NOMINAL OD (DN)		MEAN PIPE OD (MM)		THICKNESS (MM)	
(CM)	(MM)	MIN.	MAX.	MIN.	MAX.
4.0	40	40.0	40.3	1.8	2.0
5.0	50	50.0	50.3	1.8	2.2
7.5	75	75.0	75.4	2.3	2.8
9.0	90	90.0	90.4	2.8	3.3
11.0	110	110.0	110.4	3.4	4.0
16.0	160	160.0	160.5	4.9	5.6

SOCKET DIMENSION

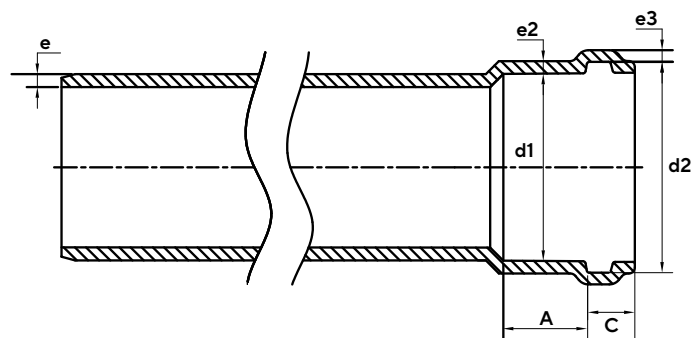

Nominal Outside Diameter DN mm (inches)	Wall Thickness of Pipe emin. (mm)	Wall Thickness of Socket e ₂ , min. (mm)	Wall Thickness of Ring Groove e ₃ , min. (mm)	Inside Diameter of Soc. d1 min. (mm)	Inside Diameter at Ring Groove d2 with tolerance (mm)	Length of Soc. Neck Cmax. (mm)	Length Beyond Ring Groove Amin. (mm)
40(1½)	1.8	1.6	1.0	40.3	49.4(+1.0/-0.0)	18	26
50(1½)	1.8	1.6	1.0	50.3	59.6(+1.0/-0.0)	18	28
75(2½)	2.3	2.1	1.3	75.3	84.5 (+1.0/0.0)	18	33
90(3½)	2.8	2.6	2.1	90.3	99.9 (+1.0/-0.0)	20	34
110(4)	3.4	3.1	2.6	110.4	120.6(+1.8/-0.0)	22	36
160(6)	4.9	4.5	3.7	160.5	174.3 (+1.8/-0.0)	32	41

DRAIN PRO PROPERTY CHART

PROPERTY	UNIT	VALUE
Material	Pipe: PP/PP mineral filled/PP	
	Fitting : PP Mineral Filled	
	Rubber Seal : SBR	
	Colour :- Dove Blue RAL 5014	
Area of Application	Drainage piping system in building and other establishment	
Density	g/cm ³	1.4
Tensile Strength	MPa	18.5
Elongation @ Break	%	32
Modulus of Elasticity	MPa	3000-3500
Coefficient of Liner Expansion	mm/mk	0.09
Ring Stiffness	kN/M ²	>6
Fire Resistance	---	D - s2, d0
Connection	Push Fit sockets with factory-inserted lip seal special rubber ring	
Application Environment	Waste water with pH 2 - 12	
Operating Temperature	Water Temp. up to 95°C/ 203°F(intermittent) or 90°C/194°F(Continuous)	
Life Expectancy	50 Years	
Reference Standard	Dimensions as per EN 1451, Series S16	

PRODUCT



DRAINPRO™

RANGE

DRAINPRO PIPES & FITTINGS



Size (cm)	Length Socket	Product Code	d (mm)(min)	d1 (mm)(min)	s (mm) (min)	t (mm)
4.0	3 M S/S	M481270304	40.0	51.9	1.8	44.0
4.0	3 M D/S	M481280304	40.0	51.9	1.8	44.0
4.0	1 RFT S/S	M 481271104	40.0	51.9	1.8	44.0
4.0	2 RFT D/S	M481282204	40.0	51.9	1.8	44.0
4.0	3 RFT D/S	M481283304	40.0	51.9	1.8	44.0
4.0	4 RFT D/S	M481284404	40.0	51.9	1.8	44.0
4.0	6 RFT S/S	M481276604	40.0	51.9	1.8	44.0
4.0	6 RFT D/S	M481286604	40.0	51.9	1.8	44.0
5.0	3 M S/S	M481270305	50.0	62.5	1.8	46.0
5.0	3 M D/S	M481280305	50.0	62.5	1.8	46.0
5.0	1 RFT S/S	M 481271105	50.0	62.5	1.8	46.0
5.0	2 RFT D/S	M481282205	50.0	62.5	1.8	46.0
5.0	3 RFT D/S	M481283305	50.0	62.5	1.8	46.0
5.0	4 RFT D/S	M481284405	50.0	62.5	1.8	46.0
5.0	6 RFT S/S	M481276605	50.0	62.5	1.8	46.0
5.0	6 RFT D/S	M481286605	50.0	62.5	1.8	46.0
7.5	3M S/S	M481270307	75.0	88	2.3	51.0
7.5	3M D/S	M481280307	75.0	88	2.3	51.0
7.5	1 RFT S/S	M 481271107	75.0	88	2.3	51.0
7.5	2 RFT D/S	M481282207	75.0	88	2.3	51.0
7.5	3 RFT D/S	M481283307	75.0	88	2.3	51.0
7.5	4 RFT D/S	M481284407	75.0	88	2.3	51.0
7.5	6 RFT S/S	M481276607	75.0	88	2.3	51.0
7.5	6 RFT D/S	M481286607	75.0	88	2.3	51.0
9.0	3M S/S	M481270308	90.0	104.1	2.8	54.0
9.0	3M D/S	M481280308	90.0	104.1	2.8	54.0
9.0	1 RFT S/S	M 481271108	90.0	104.1	2.8	54.0
9.0	2 RFT D/S	M481282208	90.0	104.1	2.8	54.0
9.0	3 RFT D/S	M481283308	90.0	104.1	2.8	54.0
9.0	4RFT D/S	M481284408	90.0	104.1	2.8	54.0
9.0	6RFT S/S	M481276608	90.0	104.1	2.8	54.0
9.0	6RFT D/S	M481286608	90.0	104.1	2.8	54.0
11.0	3M S/S	M481270309	110.0	125.6	3.4	58.0
11.0	3M D/S	M481280309	110.0	125.6	3.4	58.0
11.0	1 RFT S/S	M481271109	110.0	125.6	3.4	58.0
11.0	2 RFT S/S	M481272209	110.0	125.6	3.4	58.0
11.0	2 RFT D/S	M481282209	110.0	125.6	3.4	58.0
11.0	3 RFT D/S	M481283309	110.0	125.6	3.4	58.0
11.0	4 RFT D/S	M481284409	110.0	125.6	3.4	58.0
11.0	5 RFT D/S	M481285509	110.0	125.6	3.4	58.0
11.0	6 RFT S/S	M481276609	110.0	125.6	3.4	58.0
11.0	6 RFT D/S	M481286609	110.0	125.6	3.4	58.0
11.0	12 RFT D/S	M481271209	110.0	125.6	3.4	58.0
16.0	3 M S/S	M481270312	160.0	181.5	4.9	73.0
16.0	3M D/S	M481280312	160.0	181.5	4.9	73.0
16.0	1 RFT S/S	M481227112	160.0	181.5	4.9	73.0
16.0	2 RFT D/S	M481282212	160.0	181.5	4.9	73.0
16.0	3 RFT D/S	M481283312	160.0	181.5	4.9	73.0
16.0	4 RFT D/S	M481284412	160.0	181.5	4.9	73.0
16.0	6 RFT S/S	M481276612	160.0	181.5	4.9	73.0
16.0	6 RFT D/S	M481286612	160.0	181.5	4.9	73.0

DRAINPRO PIPES & FITTINGS

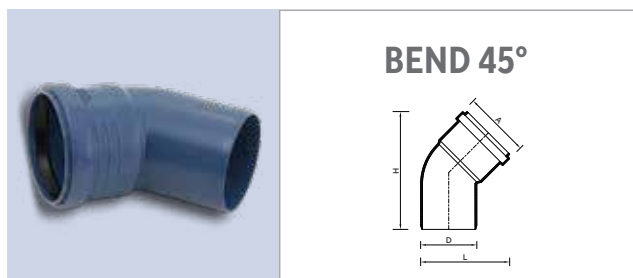

BEND 45°

Size (cm)	Product Code	A (mm)	H (mm)	L (mm)	D (mm)	W.T. (mm)	Std. Pkg. (Nos.)
4.0	M482001104	54	135	84	40	2.00	90
5.0	M482001105	63	129	89	50	2.10	55
7.5	M482001107	89	157	119	75	2.50	40
9.0	M482001108	105	176	138	90	3.05	36
11.0	M482001109	127	204	164	110	3.65	24
16.0	M482001112	183	265	225	160	5.15	10

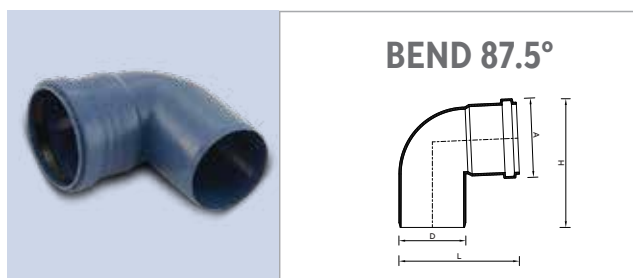

BEND 87.5°

Size (cm)	Product Code	A (mm)	H (mm)	L (mm)	D (mm)	W.T. (mm)	Std. Pkg. (Nos.)
4.0	M482001204	54	102	98	40	2.00	80
5.0	M482001205	63	113	103	50	2.10	50
7.5	M482001207	89	145	135	75	2.50	35
9.0	M482001208	105	165	156	90	3.05	24
11.0	M482001209	127	195	184	110	3.65	18
16.0	M482001212	183	262	245	160	5.15	08

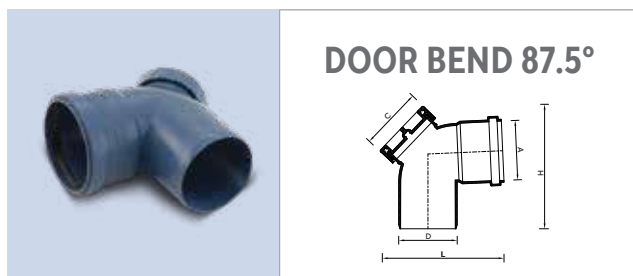

DOOR BEND 87.5°

Size (cm)	Product Code	A (mm)	H (mm)	L (mm)	C (mm)	D (mm)	W.T. (mm)	Std. Pkg. (Nos.)
7.5	M482001307	89	157	159	81	75	2.50	30
9.0	M482001308	105	173	177	81	90	3.05	24
11.0	M482001309	127	205	208	111	110	3.65	18
16.0	M482001312	183	262	258	111	160	5.15	06

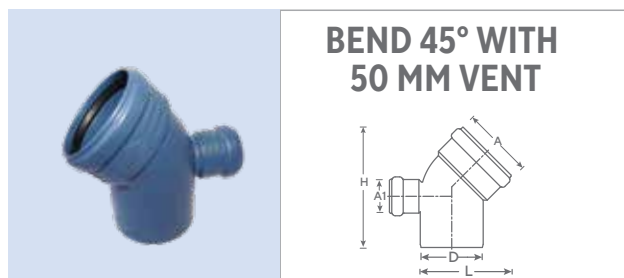

BEND 45° WITH 50 MM VENT

DN (cm)	Product Code	A x A1 (mm)	H (mm)	L (mm)	D (mm)	W.T. (mm)	Std. Pkg. (Nos.)
11.0	M4820014209	130x68	209	220	110	5.5	01

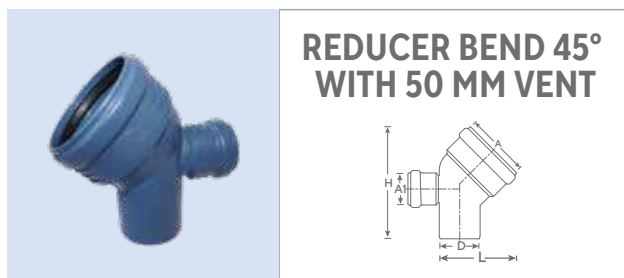

REDUCER BEND 45° WITH 50 MM VENT

DN (cm)	Product Code	A x A1 (mm)	H (mm)	L (mm)	D (mm)	W.T. (mm)	Std. Pkg. (Nos.)
11.0x7.5	M4820014229	130x68	205	200	75	5.5	01

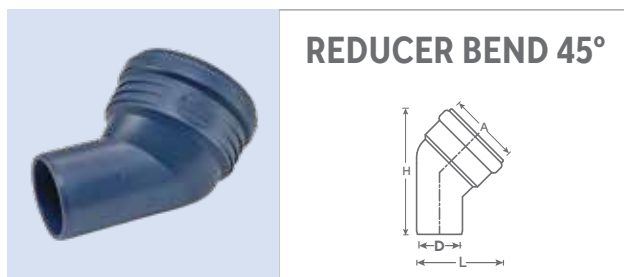

REDUCER BEND 45°

DN (cm)	Product Code	A x A1 (mm)	H (mm)	L (mm)	D (mm)	W.T. (mm)	Std. Pkg. (Nos.)
11.0 x 7.5	M482001129	130	205	145	75	5.5	01

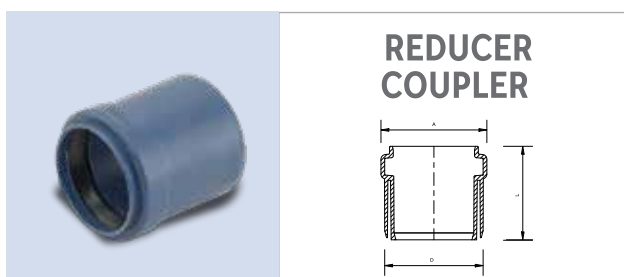

REDUCER COUPLER

Size (cmxcm)	Product Code	A (mm)	L (mm)	D (mm)	W.T. (mm)	Std. Pkg. (Nos.)
5.0x4.0	M482004841	48	54	50	4.3	150

DRAINPRO

PIPES & FITTINGS

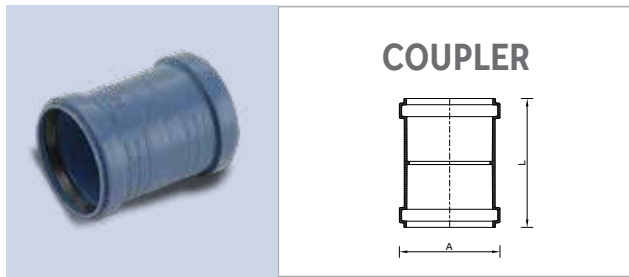

COUPLER

Size (cm)	Product Code	A (mm)	L (mm)	W.T. (mm)	Std. Pkg. (Nos.)
4.0	M482001604	54	95	2.00	100
5.0	M482001605	63	100	2.10	72
7.5	M482001607	89	114	2.50	54
9.0	M482001608	105	122	3.05	54
11.0	M482001609	127	136	3.65	45
16.0	M482001612	183	163	5.15	12

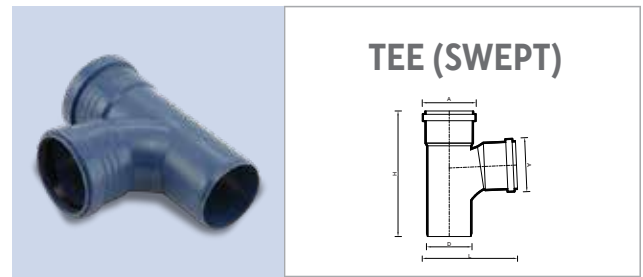

TEE (SWEPT)

Size (cm)	Product Code	A (mm)	H (mm)	L (mm)	D (mm)	W.T. (mm)	Std. Pkg. (Nos.)
4.0*	M482000104	54	145	102	40	2.00	40
5.0*	M482000905	63	153	110	50	2.10	55
7.5	M482000907	89	207	157	75	2.50	32
9.0	M482000908	105	230	183	90	3.05	24
11.0	M482000909	127	269	214	110	3.65	15
16.0	M482000912	183	353	279	160	5.15	04

*Without Swept

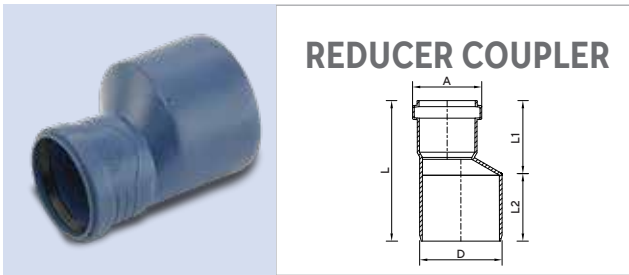

REDUCER COUPLER

Size (cmxcm)	Product Code	A (mm)	L (mm)	L1 (mm)	L2 (mm)	D (mm)	W.T. (mm)	Std. Pkg. (Nos.)
7.5X5.0	M482004837	63	128	67	62	75	2.50	120
9.0X7.5	M482004830	89	135	69	67	90	3.05	40
11.0X5.0	M482004844	63	162	88	74	110	3.65	31
11.0X7.5	M482004829	89	154	80	74	110	3.65	63
11.0X9.0	M482004843	105	149	76	73	110	3.65	55
16.0X7.5	M482004835	89	198	111	87	160	5.15	24
16.0X9.0	M482004872	105	193	106	87	160	5.15	24
16.0X11.0	M482004831	127	189	102	87	160	5.15	24

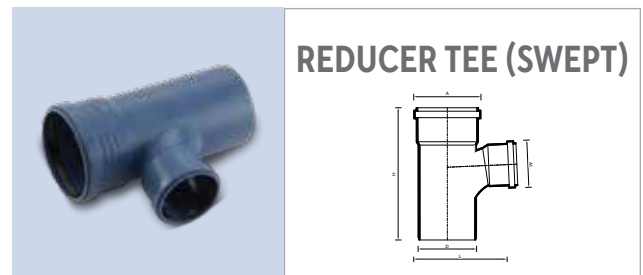

REDUCER TEE (SWEPT)

Size (cmxcm)	Product Code	A (mm)	A1 (mm)	H (mm)	L (mm)	D (mm)	W.T. (mm)	Std. Pkg. (Nos.)
11.0X5.0	M482004244	127	63	249	174	110	3.65	20
11.0X7.5	M482004229	127	89	249	196	110	3.65	20
16.0X7.5	M482004235	183	89	279	249	160	5.15	08
16.0X11.0	M482004231	183	127	298	268	160	5.15	05

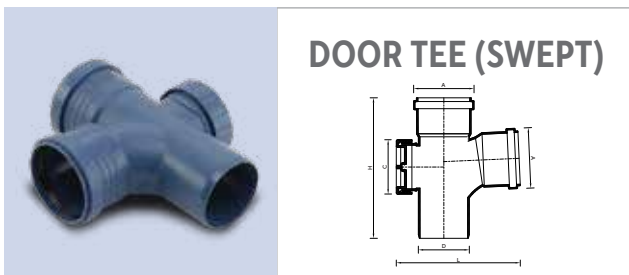

DOOR TEE (SWEPT)

Size (cm)	Product Code	A (mm)	H (mm)	L (mm)	C (mm)	D (mm)	W.T. (mm)	Std. Pkg. (Nos.)
7.5	M482001007	89	207	183	81	75	2.50	24
9.0	M482001008	105	230	208	81	90	3.05	17
11.0	M482001009	127	269	242	111	110	3.65	11
16.0	M482001012	183	353	311	111	160	5.15	04

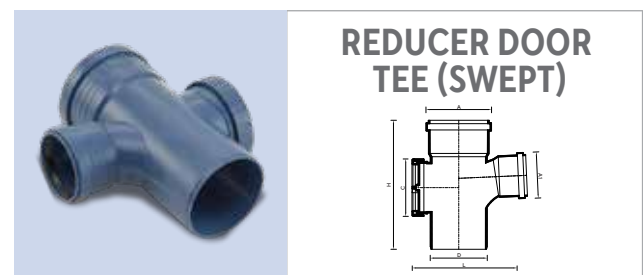

REDUCER DOOR TEE (SWEPT)

Size (cmxcm)	Product Code	A (mm)	A1 (mm)	H (mm)	L (mm)	C (mm)	D (mm)	W.T. (mm)	Std. Pkg. (Nos.)
11.0X5.0	M482004344	127	63	249	201	111	110	3.65	14
11.0X7.5	M482004329	127	89	249	223	111	110	3.65	13
16.0X7.5	M482004335	183	89	279	273	111	160	5.15	08
16.0X11.0	M482004331	183	127	298	292	111	160	5.15	05

DRAINPRO PIPES & FITTINGS

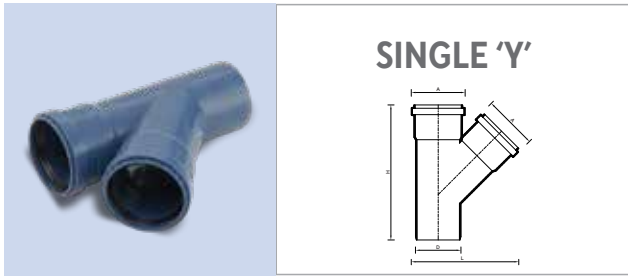

Size (cm)	Product Code	A (mm)	H (mm)	L (mm)	D (mm)	W.T. (mm)	Std. Pkg. (Nos.)
4.0	M482001904	54.0	161.0	115.0	40	1.90	40
5.0	M482001905	63.0	175.0	129.0	50	2.10	50
7.5	M482001907	89.0	223.0	175.0	75	2.50	17
9.0	M482001908	105.0	253.0	207.0	90	3.05	21
11.0	M482001909	127.0	299.0	248.0	110	3.65	14
16.0	M482001912	183.0	396.0	347.0	160	5.15	03

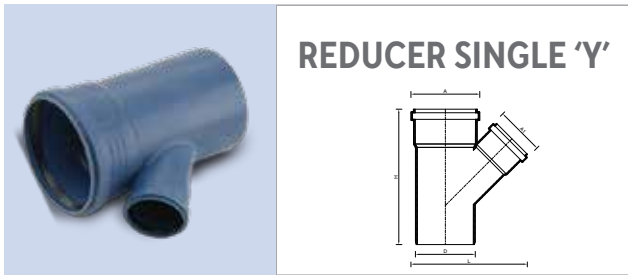

Size (cmxcm)	Product Code	A (mm)	A1 (mm)	H (mm)	L (mm)	D (mm)	W.T. (mm)	Std. Pkg. (Nos.)
11.0X7.5	M482002129	127	89	249	214	110	3.65	15
16.0X7.5	M482002135	183	89	282	267	160	5.15	05
16.0X11.0	M482002131	183	127	322	300	160	5.15	05

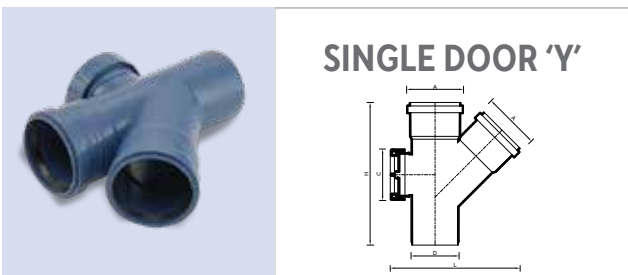

Size (cmxcm)	Product Code	A (mm)	H (mm)	L (mm)	C (mm)	D (mm)	W.T. (mm)	Std. Pkg. (Nos.)
7.5	M482002007	89	223	203	81	75	2.50	16
9.0	M482002008	105	253	232	81	90	3.05	16
11.0	M482002009	127	299	275	111	110	3.65	12
16.0	M482002012	183	396	370	111	160	5.15	03

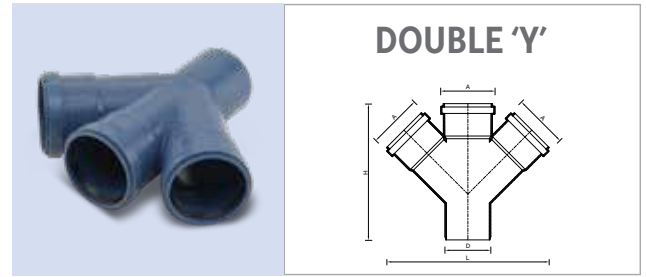

Size (cm)	Product Code	A (mm)	H (mm)	L (mm)	D (mm)	W.T. (mm)	Std. Pkg. (Nos.)
7.5	M482002307	89	223	266	75	2.50	11
11.0	M482002309	127	299	369	110	3.65	08
16.0	M482002312	183	396	510	160	5.15	03

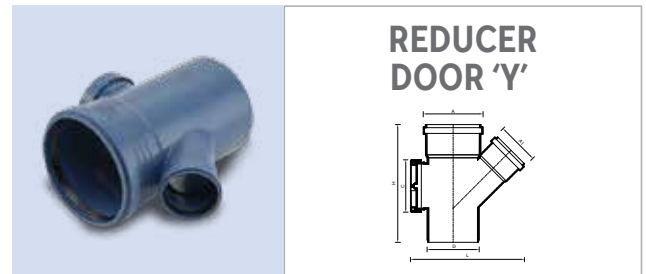

Size (cmxcm)	Product Code	A (mm)	A1 (mm)	H (mm)	L (mm)	C (mm)	D (mm)	W.T. (mm)	Std. Pkg. (Nos.)
11.0X7.5	M482002229	127	89	249	241	111	110	3.65	14
16.0X7.5	M482002235	183	89	282	291	111	160	5.15	05
16.0X11.0	M482002231	183	127	322	325	111	160	5.15	04

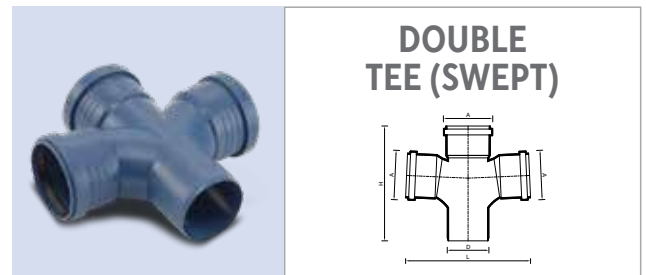

Size (cmxcm)	Product Code	A (mm)	H (mm)	L (mm)	D (mm)	W.T. (mm)	Std. Pkg. (Nos.)
7.5	M482005407	89	207	225	75	2.55	30
11.0	M482005409	127	269	196	110	3.65	08

DRAINPRO PIPES & FITTINGS

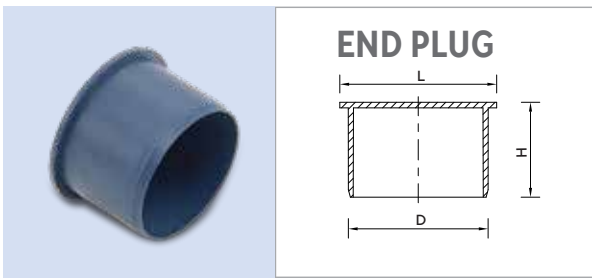

Size (cm)	Product Code	H (mm)	L (mm)	D (mm)	W.T. (mm)	Std. Pkg. (Nos.)
5.0	M482002905	45	59	50	2.10	180
7.5	M482002907	51	84	75	2.60	78
9.0	M482002908	55	99	90	3.05	80
11.0	M482002909	62	119	110	3.65	53
16.0	M482002912	60	175	160	5.60	28

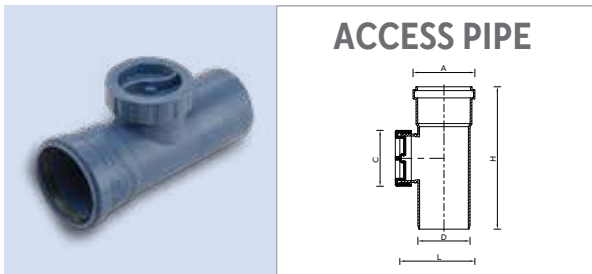

Size (cmxcm)	Product Code	A (mm)	H (mm)	L (mm)	C (mm)	D (mm)	W.T. (mm)	Std. Pkg. (Nos.)
7.5	M482005307	89	205	115	81	75	2.50	41
9.0	M482005308	105	235	130	81	90	3.05	25
11.0	M482005309	127	271	154	111	110	3.65	20
16.0	M482005312	183	310	207	111	160	5.15	08

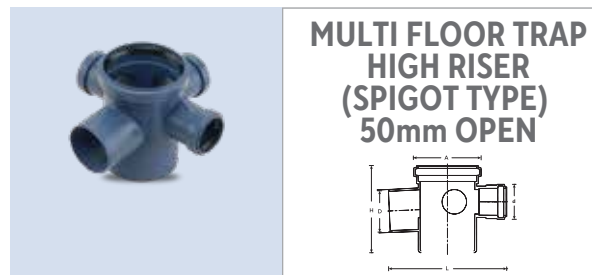

Size (cm)	Height (inch)	Product Code	A (mm)	H (mm)	L (mm)	D (mm)	d (mm)	W.T. (mm)	Std. Pkg. (Nos.)
11.0x7.5x (3)5.0	6	M482005709	127	165	230	75	66	3.0	12

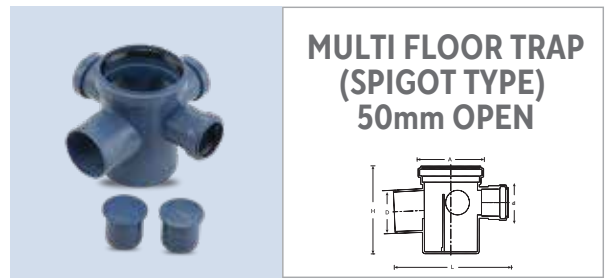

Size (cmxcm)	Height (inch)	Product Code	A (mm)	H (mm)	L (mm)	D (mm)	d (mm)	W.T. (mm)	Std. Pkg. (Nos.)
11.0x7.5x (3)5.0	6	M482005609	127	165	230	75	66	3.0	12

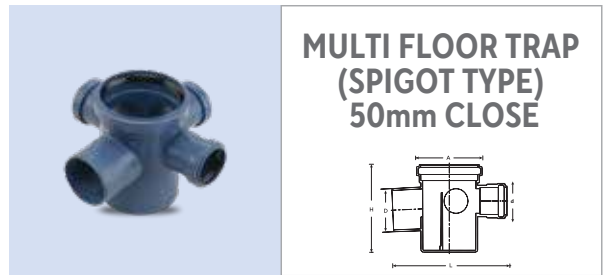

Size (cmxcm)	Height (inch)	Product Code	A (mm)	H (mm)	L (mm)	D (mm)	d (mm)	W.T. (mm)	Std. Pkg. (Nos.)
11.0x7.5x (3)5.0	6	M482006309	127	165	230	75	66	3.0	12

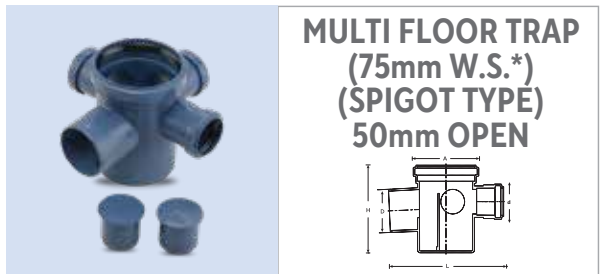

Size (cmxcm)	Height (inch)	Product Code	A (mm)	H (mm)	L (mm)	D (mm)	d (mm)	W.T. (mm)	Std. Pkg. (Nos.)
11.0x7.5x (3)5.0	7	M482005809	127	190	230	75	66	3.5	12



Size (cmxcm)	Height (inch)	Product Code	A (mm)	H (mm)	L (mm)	D (mm)	d (mm)	W.T. (mm)	Std. Pkg. (Nos.)
11.0x7.5x (3)5.0	7	M482006209	127	190	230	75	66	3.5	12

DRAINPRO PIPES & FITTINGS

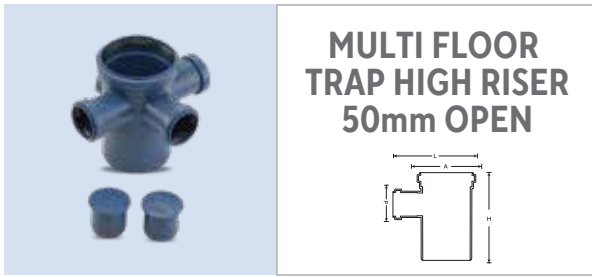

**MULTI FLOOR
TRAP HIGH RISER
50mm OPEN**

Size (cmxcm)	Height (inch)	Product Code	A (mm)	H (mm)	L (mm)	d (mm)	W.T. (mm)	Std. Pkg. (Nos.)
11.0x(3)5.0	7	M482005909	127	190	180	66	3.5	12



**MULTI FLOOR
TRAP HIGH RISER
50mm CLOSE**

Size (cmxcm)	Height (inch)	Product Code	A (mm)	H (mm)	L (mm)	d (mm)	W.T. (mm)	Std. Pkg. (Nos.)
11.0x(3)5.0	7	M482006009	127	190	180	66	3.5	12



**PLAIN FLOOR
TRAP
(SPIGOT TYPE)**

Size (cmxcm)	Height (inch)	Product Code	A (mm)	H (mm)	L (mm)	D (mm)	W.T. (mm)	Std. Pkg. (Nos.)
11.0x7.5	6	M482006409	127	165	175	75	3.5	12
11.0x7.5	7	M482006909	127	190	175	75	3.5	12

W.S. Water Seal, 7" W.S. - 75 mm, 6" W.S. - 50 mm

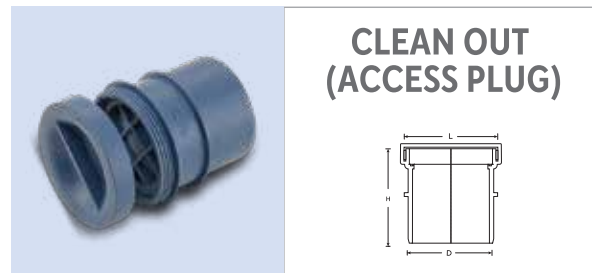

**CLEAN OUT
(ACCESS PLUG)**

Size (cm)	Product Code	H (mm)	L (mm)	D (mm)	W.T. (mm)	Std. Pkg. (Nos.)
11.0	M4820010109	122	130	110	5.5	20

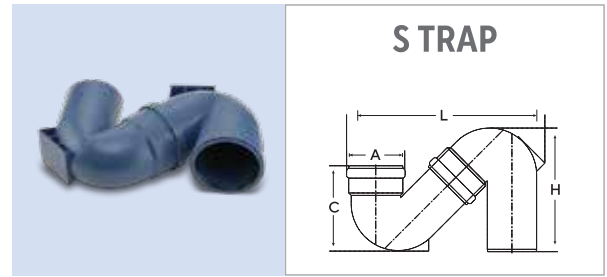

S TRAP

Size (cmxcm)	Product Code	A (mm)	H (mm)	L (mm)	C (mm)	W.T. (mm)	Std. Pkg. (Nos.)
11.0x11.0	F482003709	127	230	400	190	3.5	06

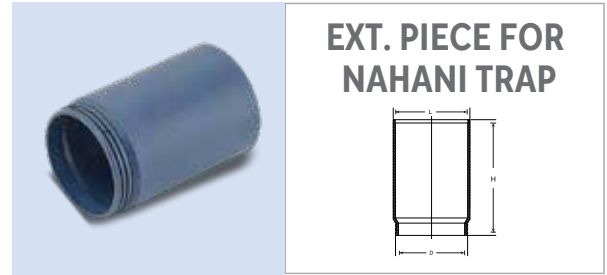

**EXT. PIECE FOR
NAHANI TRAP**

Size (cmxcm)	Product Code	H (mm)	L (mm)	D (mm)	W.T. (mm)	Std. Pkg. (Nos.)
11.0	M4820014409	176	117	110	3.5	34

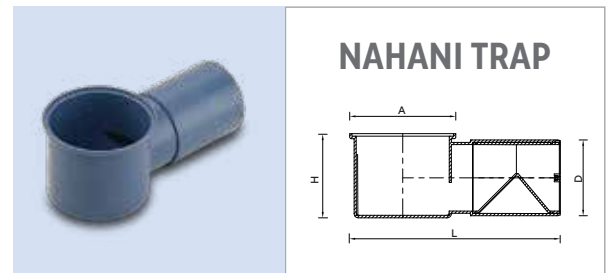

NAHANI TRAP

Size (cmxcm)	Product Code	A (mm)	H (mm)	L (mm)	D (mm)	W.T. (mm)	Std. Pkg. (Nos.)
11.0X7.5	M482003129	126.0	85.0	250.0	110	3.2	22
11.0X9.0	M482003143	126.0	100.0	250.0	110	3.0	33
11.0X11.0	M482003109	126.0	120.0	260.0	110	2.8	25

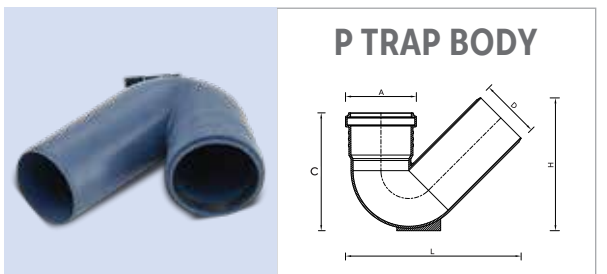

P TRAP BODY

Size (cmxcm)	Product Code	A (mm)	H (mm)	L (mm)	C (mm)	D (mm)	W.T. (mm)	Std. Pkg. (Nos.)
7.5x7.5	M482003507	89	167	148	221	75	2.5	28
11.0x11.0	M482003509	127	230	196	307	110	3.0	12

DRAINPRO

PIPES & FITTINGS



WC CONNECTOR

Size (cmxcm)	Product Code	L (mm)	H (mm)	W.T. (mm)	Std. Pkg. (Nos.)
11.0	M4812910609	300	122	3.5	6
11.0	M481295709	600	122	3.5	3

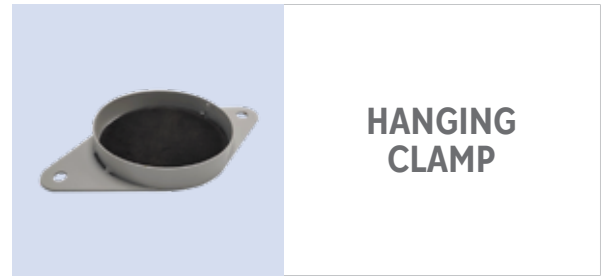

HANGING CLAMP

Qty. (cm)	Product Code	Pkg.(Nos.) Std. Mast.
11.0	T107-040	05 05

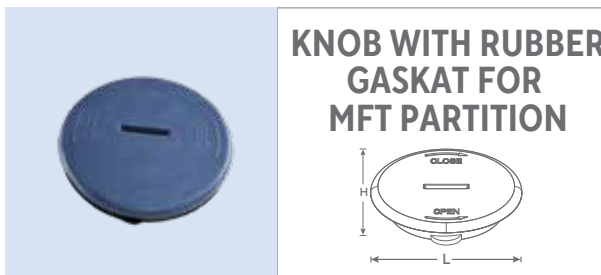

KNOB WITH RUBBER GASKAT FOR MFT PARTITION

Size (cm)	Height (inch)	Product Code	H (mm)	L (mm)	W.T. (mm)	Std. Pkg. (Nos.)
11.0	6&7	M482005100	10	53	2.6	01



SAFETY CLIP FOR SOCKET PLUG (END CAP)

Size (cm)	Product Code	Pkg.(Nos.) Std. Mast.
7.5	SC-075-EC*	10 100
11.0	SC-110-EC*	20 80
16.0	SC-160-EC*	06 60

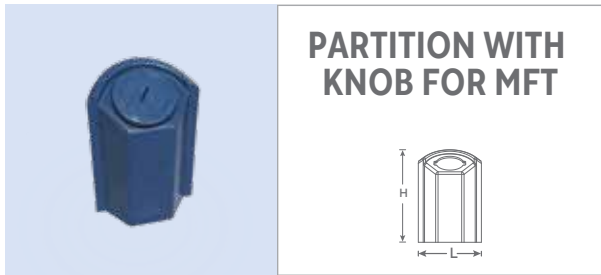

PARTITION WITH KNOB FOR MFT

Size (cm)	Height (inch)	Product Code	H (mm)	L (mm)	W.T. (mm)	Std. Pkg. (Nos.)
11.0	6	M482005000R	113	95	2.6	100
11.0	7	M482006100R	138	95	2.6	75



SAFETY CLIP FOR COUPLER CLAMP

Size (cm)	Product Code	Pkg.(Nos.) Std. Mast.
7.5	SC-075-CC*	10 100
11.0	SC-110-CC*	10 100
16.0	SC-160-CC*	06 60

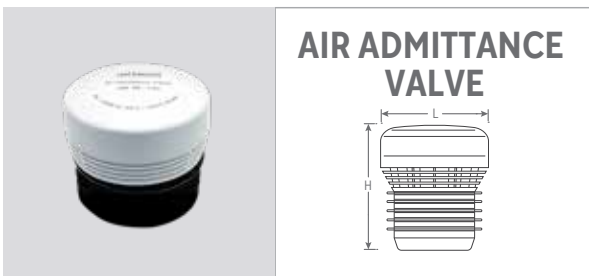

AIR ADMITTANCE VALVE

Size (cm)	Item Type	Product Code	H (mm)	L (mm)	Std. Pkg. (Nos.)
3.2-6.3	Mini	HYPERAIR-32.63	78	70	140
7.5-11.0	Maxi	HYPERAIR-70.110	106	125	12



SPLIT CLAMPS

Size (cm)	Product Code	Pkg.(Nos.) Std. Mast.
4.0	T101-012R*	25 250
5.0	T101-015R*	25 250
6.3	T101-020R*	25 250
7.5	T101-025R*	25 200
9.0	T101-030R*	15 150
11.0	T101-040R*	10 100
16.0	T101-060R*	10 100

DRAINPRO PIPES & FITTINGS



**HEAVY DUTY SADDLE
WITH RUBBER**

Size (cm)	Product Code	Pkg.(Nos.) Std. Mast.	
4.0	T105-012R*	-	-
5.0	T105-015R**	-	-
6.3	T105-020R**	20	200
7.5	T105-025R*	32	320
11.0	T105-040R*	24	240
16.0	T105-060R*	12	120



**RUBBER
SEALING RING**

Size (cm)	Product Code	Std. Pkg. (Nos.)
4.0	RM06311040	01
5.0	RM06311050	01
7.5	RM06312075	01
9.0	RM06312090	01
11.0	RM06311110	01
16.0	RM06311160	01



**RUBBER O RING
FOR ACCESS DOOR**

Size (cm)	Product Code	Std. Pkg. (Nos.)
7.5	RM06390031	01
11.0	RM06390032	01



RESCUE TAPE

Size (Ft.)	Product Code	Std. Pkg. (Nos.)
5	M005601010	120
5	M005601015	120
5	M005601005	120
10	M005601025	120
10	M005601030	120
10	M005601020	120
15	M005601040	120
15	M005601045	120
15	M005601035	120



**PTFE TAPE
(12 MM WIDTH)**

Size (Mtr.)	Product Code	Std. Pkg. (Nos.)
4	M003302004	01
8	M003302007	01
8	M003302017	01



**BONDSET
FAST SETTING**

Qty. (gm)	Product Code	Std. Pkg. (Nos.)
50	M000702051	01
100	M000702050	01



**PIPE JOINT
LUBRICANT**

Qty. (gm)	Product Code	Std. Pkg. (Nos.)
100	STINS-100	100
250	STINS-250	40
500	STINS-500	20

INSTALLATION PROCEDURE

PIPE CUTTING

Astral DrainPro is manufactured to be cut simply with a pipe cutter or a saw. Be sure that the cut is done at a 90° angle on the pipe axis. Remove all burrs, cutting residues as well as sharp edges and clean the pipe end. Pipe ends need to be chamfered only while making a connection with fittings. Chamfering might not be needed while connecting to the compensator or end of the compensator.

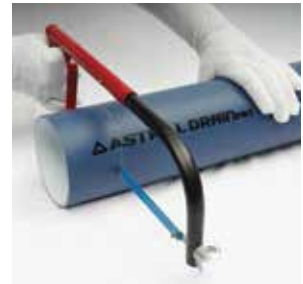

PUSH-FIT JOINTS WITHOUT COMPENSATOR SOCKET

For pipe-fitting connections with a maximum length of 3 meters / 9.5 feet, it is necessary to consider that a maximum of 10 mm / 0.4 inches can be removed from the sleeve due to thermal expansion.

Due to length variations caused by thermal effects, push-fit connections between fittings can be slotted fully.

The push-fit coupling is done as follows:



Check the position and the condition of the lip seal in the coupler channel. If necessary, clean the fitting and the gasket. Clean the push-fit end of the pipe and the fitting.



Apply a thin uniform layer of Astral lubricant on the end of the coupling. Do not use oil or grease.



Place the end into the coupler and push in firmly.

Slide the pipe and not the fitting just 10 mm / 0.4 inches out of the coupling. When pipes are positioned vertically, leave space of 10 mm / 0.4 inches to avoid slipping and for elimination of the dilatation. Then fix the individual pipes with collars immediately after assembly.



FIXATION

It is advisable to install the Astral DrainPro SWR drainage system tension-free and with adequate lateral allowance for temperature compensation. Use rubber-line brackets. To prevent joints from sliding apart, pipe brackets must be fitted with corrugated rubber inserts and the wall must be secured with plastic plugs. For pipe system with inner-pressures, the joints must be secured in order to prevent them from deviating from the centre axis. Alternatively, the fixing brackets can be arranged appropriately so that joints can be prevented from sliding apart and the same effect can be achieved with the Astral safety clips.

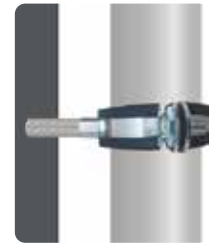

VERTICAL SUPPORT

FIXING BRACKET

After the screws are tightened, the pipe or fitting cannot move through the fixed brackets (no longitudinal movement is possible). A fixed bracket must be attached to each individual pipe length in order to prevent the vertical stack from falling. Every horizontally installed pipe should always be fixed with a single fixed bracket, regardless of whether the fitting or group of fittings are fixed. Both vertical and horizontal pipe brackets must be sliding brackets with the distance that do not exceed the prescribed values.

SLIDING BRACKET

Even after the screws have been tightened on the sliding brackets, the pipe can still be moved through it longitudinally.



CORRECT



INCORRECT

External heating of Astral DrainPro Pipes should be limited by heat insulating the source; e.g. central heating pipes as well as hot tap water pipes. Pipe and shaft dimensions are to be taken from the table below.

Nominal OD (DN) (mm) (inches)	Mean Pipe OD (mm)	OD of Socket dm (mm)	Min. Required Spacing* (mm)
40 (1¼)	40.0	51.9	125
50 (1½)	50.0	62.5	125
75 (2½)	75.0	88.0	155
90 (3½)	90.0	104.1	165
110 (4)	110.0	125.6	190
160 (6)	160.0	181.5	244

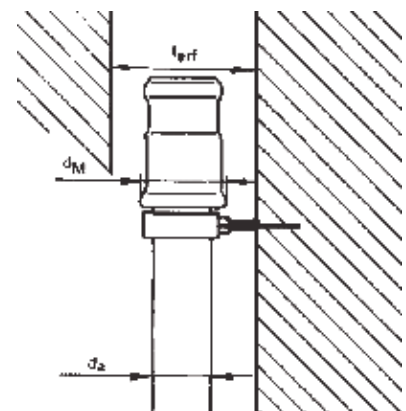

* The stated depths are not including pipe crossings

Space requirements for Astral DrainPro pipes DN 40 – DN 200 mm.

INSTALLATION IN CONCRETE

Astral DrainPro pipes and fittings can be cast in concrete. It is crucial to adhere to the instructions when dealing with thermally induced lateral movements.

- Attach pipe component in such a way that a change in position during concrete application is prevented.
- Seal the sleeve gap with adhesive strips to prevent the penetration of concrete.
- Seal the pipe opening before concrete application.

WALL AND CEILING INSTALLATIONS

If a flooring substitute is to be applied, then the exposed pipes should be encased in soft material like glass-wool or foam or locked in protecting tubes. Wall and ceiling installations should be moisture proof and sound absorbing.

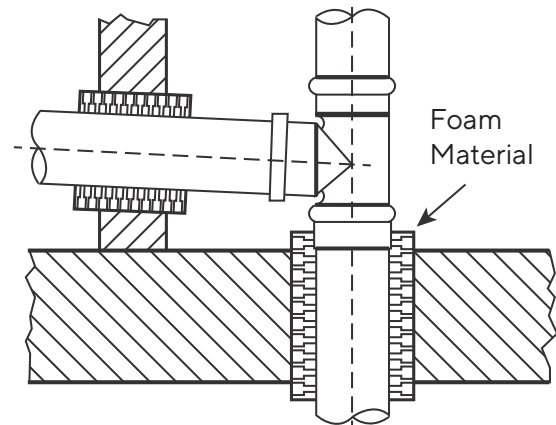

ROOF DRAINAGE PIPES

Roof drainage pipes projected through living, sleeping and working rooms can be installed as shown in the diagram. The specific area weight of the casting should be at least equal to the wall and preferably for both at least 220 kg/m². Although the formation of condensation on the outside of Astral DrainPro pipes is less than that of metallic pipes, it is recommended to insulate the pipes and fittings.

BELOW-GROUND PIPING AND COLLECTOR PIPES

Typically buried below ground piping connects to drainage system or directly to wastewater treatment facilities located in the basements. Such piping is usually buried within the walls of the building or below the foundation. These pipes are used to collect wastewater from down-pipes or other pipe connections aboveground.

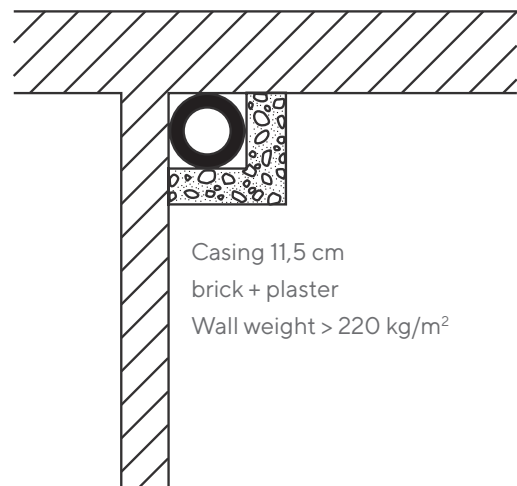

ARRANGEMENTS OF THE BRACKETS

During installation of Astral DrainPro pipes, the following should be considered:

- In horizontal installation, the pipe bracket distances are 10 times the outside diameter of the pipe. For vertical installation, the distances are 1-2 metre (3 to 6 feet), depending on outside diameter
- Generally, pipe brackets should not be installed in impact areas (e.g. diameter reductions and changes of directions in the system)
- A pipe bracket should be attached to a building material with a high specific area weight
- For stacking pipes in open mounting shafts and high rooms (storey height over 2.5 metre / 8 feet), It is advised to use one fixed bracket and one sliding bracket per pipe length
- The fixed bracket must be installed directly above the fitting at the bottom of the pipe end. The sliding bracket must be installed at a distance of maximum of 2 metre / 6 feet above the fixed bracket
- In buildings more than 3 floors, stack pipes of DN 100 or greater must be secured by additional fixing (stack pipe support) against sliding. Our recommendation is to use the Astral DrainPro socketed short length with a fixed bracket. Short pipes or stack segments with fittings should be secured with pipe brackets at such short distance so that they cannot slide apart

For exceptional cases, in which other connecting elements than the compensator socket is used (e.g. double socketed sleeves), two brackets should be installed in parallel per maximum allowable pipe length of 3 metre / 9.8 feet, as illustrated on this page. The double socketed sleeves are to be fixed

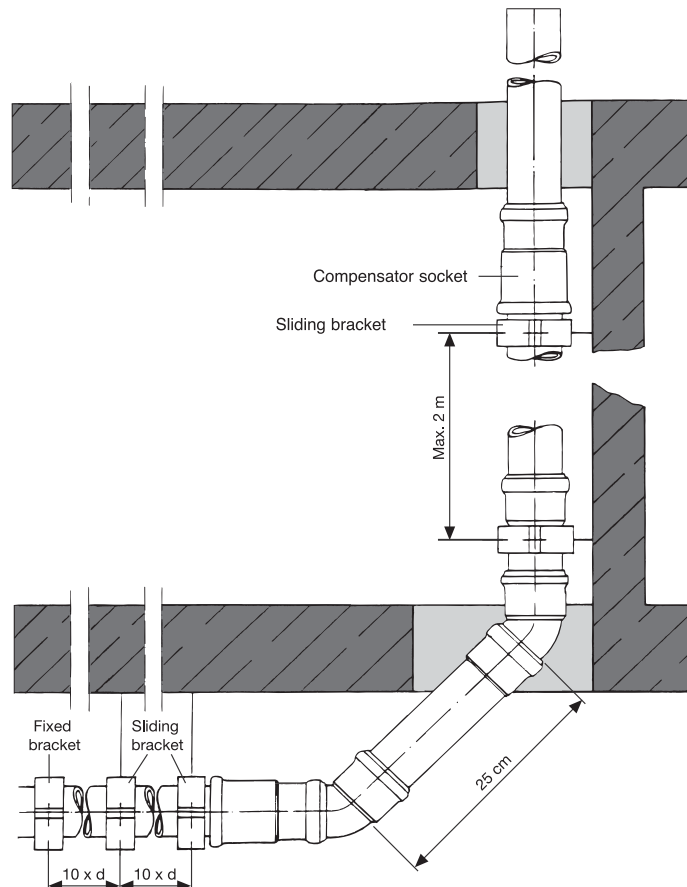

SUPPORT SPACING DISTANCES

VERTICAL PIPE ROUTING

As a principle, 2 brackets are fitted for each floor-level. One fixed bracket is fitted to the pipe running below a socket in the lower floor level. The sliding bracket is attached loosely to the plain pipe to allow the linear expansion of the pipe run.

HORIZONTAL PIPE ROUTING

The pipe run must be secured against lateral shifting or axial movement in the proximity of all points of directional changes.

MAXIMUM DISTANCES BETWEEN THE BRACKETS FOR HORIZONTAL AND VERTICAL INSTALLATION

Pipe DN (external diameter) mm (inches)	Max. brackets distance for Horizontal installing - L Max Metre (feet)	Max. brackets distance for Vertical installing - L Max Metre (feet)
40 (1½)	0.70 (2.2')	1.30 (4.2')
50 (1½)	0.80 (2.6')	1.50 (4.9')
75 (2½)	1.10 (3.6')	2.00 (6.5')
90 (3½)	1.40 (4.5')	2.00 (6.5')
110 (4)	1.65 (5.4')	2.00 (6.5')
160 (6)	2.40 (7.8')	2.00 (6.5')

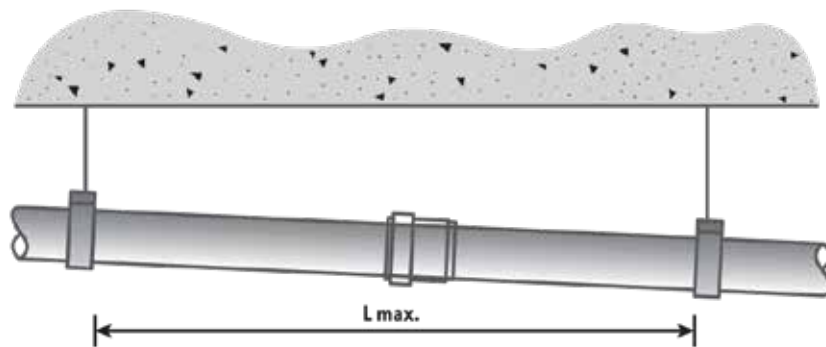

Horizontal Pipe Routing

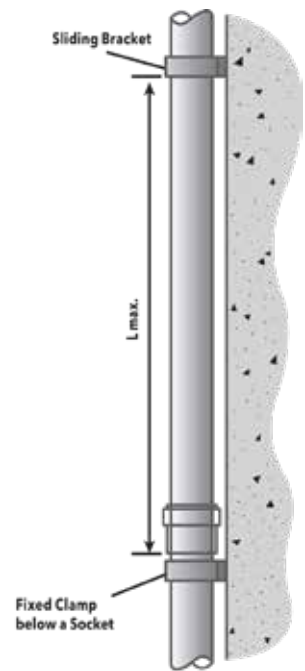

Vertical Pipe Routing

In case of the possibility of flooding of the system, it is advisable to use the rigid support system as mentioned in the below drawing. It is also advisable to use the safety clip for the coupler/socket joint. Safety clips can be used at the bottom diversion of a high-rise stack. It can provide extra protection to the joint against flow coming at high velocity from the top floors of a high-rise stack.

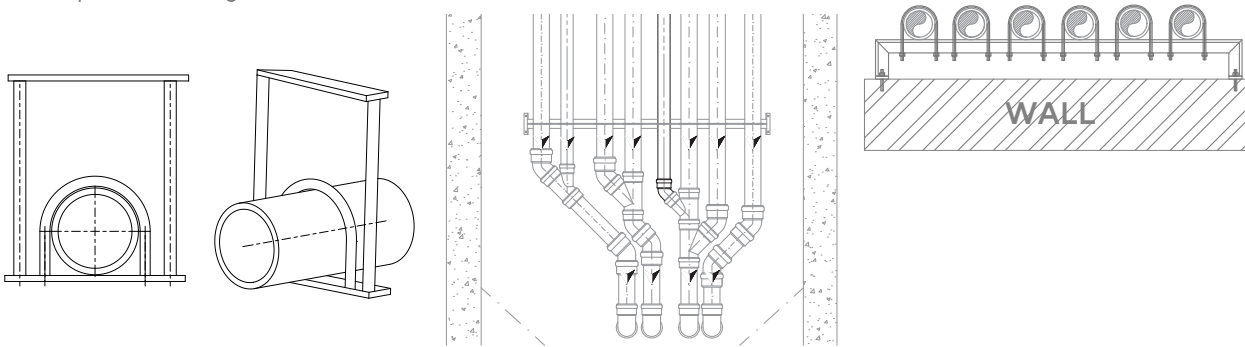

LOADING AND TRANSPORTATION



When loading, pipes and fittings should be handled in such a way that no damage occurs during transportation. Wherever possible, during transportation the pipes should rest in their entire length on top of each other, so that sagging can be avoided. Avoid sudden and abrupt stresses on pipes and fittings, especially with temperatures in the frost range.

UNLOADING AND STORAGE

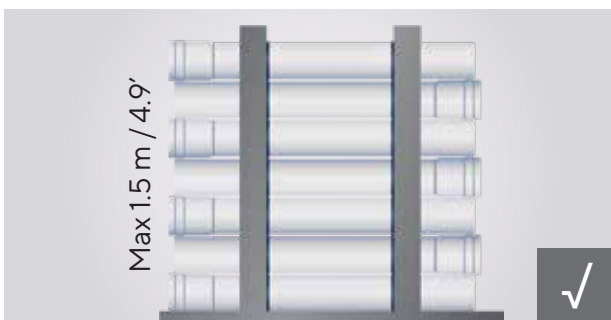

Unloading is to be carried out with appropriate care. Do not drop pipes or drag them over the ground. Furthermore, make sure that the pipes are not pulled over sharp edges (e.g. tailgate). Unpalletized pipes should not be stacked higher than 1.5 m. (4.9') pipe stacks must be secured against rolling apart.

Fittings are packed in cartons. Protect carton-packed fittings against moisture.

OUTDOOR EXPOSURE

Astral DrainPro pipes and fittings are designed to withstand outdoor storage:

Longer outdoor storage periods and intense exposure to direct sunlight might lead to discolouration of the surface.

SPECIAL FITTINGS FOR CLEANING AND MAINTENANCE



DOOR FITTINGS AND ACCESS PIPE

Astral DrainPro Piping system has provision of many access and door fittings which are very essential for repair and maintenance of sewerage and drainage piping system. These fittings are designed and manufactured with very high degree of accuracy which makes the system more effective and proven over the years. The door fittings are uniquely designed with additional inner cap attached with door cap for smoother and turbulence free flow.

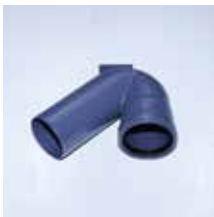

P TRAP SIPHON SYSTEM

Astral Drain Pro P Trap Siphon provides 50 mm / 2 inches water seal to prevent foul odour coming out of the drainage line. The P Trap Siphon is to be used together with bend 45°. While installing the P Trap, it is important to install the pipe support properly to ensure the safe operation of drainage system. The P Traps are available in both 75mm and 110mm sizes.



MULTI FLOOR TRAP

The highly functional Floor Trap design by Astral complies with latest international standards. The proven seal construction gives not only the top inlet but inlets and outlets on all branches to perform with the reliability and maintain functionality. Baffle Partition construction is air-tight at all working condition of Trap. Specially designed inspection plug enables to access the area under the baffle in order to inspect and clean this area. These Multi Floor Traps are available with 5" and 7" height options with 50mm and 75mm water seal respectively which can be used to design the highly efficient drainage system. Not only that, there are multiple height riser options available which can be used with Multi Floor traps to provide enormous flexibility to designers and ultimately provides efficient and cost effective solution to the specifiers.



NAHANI TRAP WITH EXTENSION PIECE

Astral DrainPro is also having uniquely designed Nahani Trap in its product range. This Nahani Trap is also having Height Riser extension piece to provide flexibility to designers where the limitation of height is observed.



RUBBER RINGS

All the rubber rings are used of SBR rubber complying to EN 681-1 specification.

CHEMICAL RESISTANCE CHART

PIPE AND FITTING

In most cases, specifications are used for orienting the chemical resistance of the material (not its ability to withstand corrosive agents) and cannot simply be applied to all situations. Mechanical behaviour can be impaired by tension and chemical interaction at the same time (tension-fracture corrosion).

RUBBER SEALING RING

The rubber used for sewer connection is generally quite resistant to chemicals, but components of esters, ketones, aromatic and chlorinated hydrocarbons, which are present in sewer water may cause it to expand heavily.

If in doubt, we recommend testing the suitability of the pipe, fitting and seal material in existing systems or have them checked in a laboratory. Contact our applications department if necessary.

TABLE LEGEND

r = resistant

cr = conditionally resistant

nr = not resistant

- = not tested

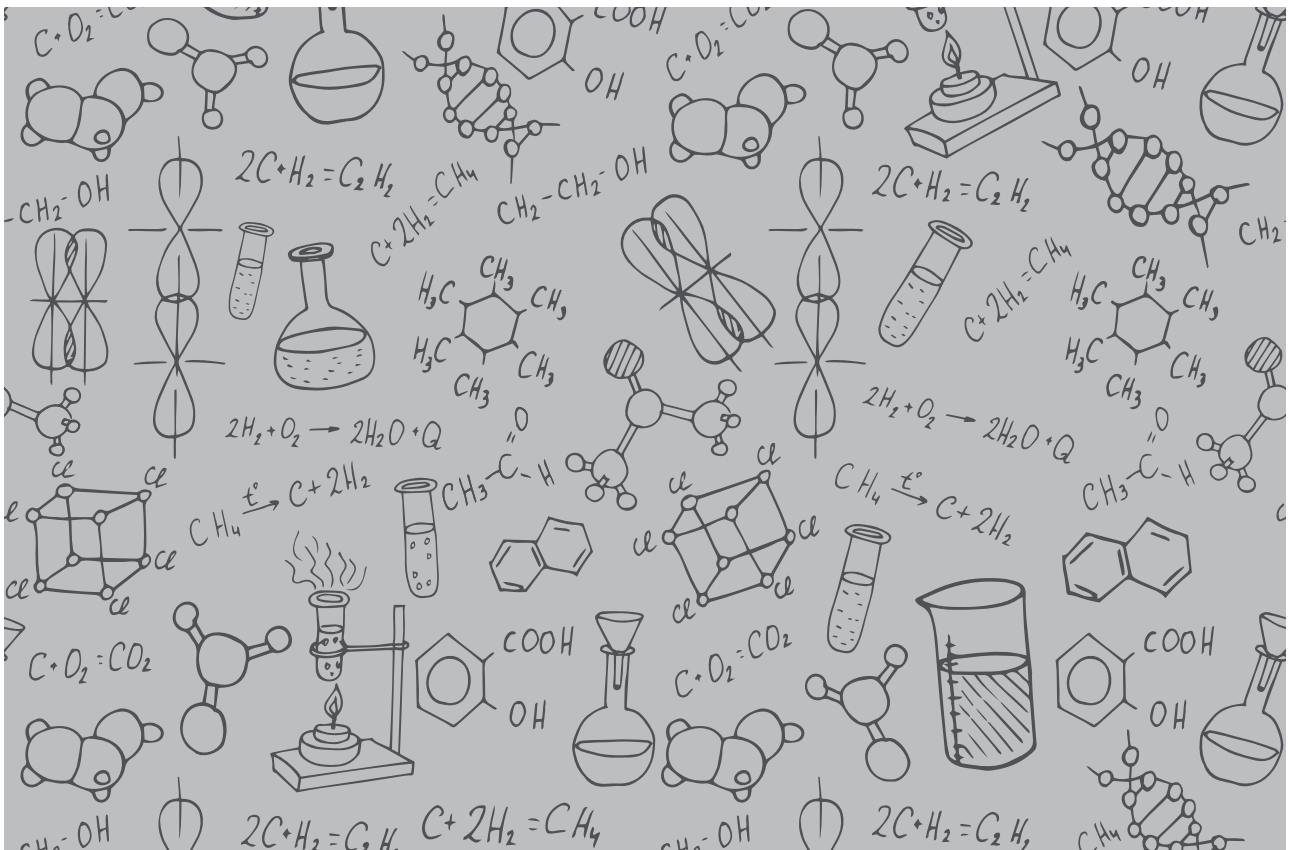

CHEMICAL RESISTANCE CHART

CHEMICAL	Concentr, %	Temp. °C	DrainPro PP
2-Propen-1-ol	96	20	r
	96	60	r
Acetaldehyde + acetic acid	90/10	20	-
Acetaldehyde, aqueous	40	40	r
Acetaldehyde, concentrated	100	20	-
Acetate ether	100	20	-
Acetic acid, aqueous	up to 25	40	r
	up to 25	60	r
	25-60	60	r
	80	40	r
Acetic acid, concentrated	95	40	-
Acetic anhydride	100	20	r
	100	40	cr
	100	60	cr
Acetone	100	20	r
	100	60	r
Acetone, aqueous	traces	20	r
Acronal dispersions	com. avail.	20	-
Acronal solutions	com. avail.	20	-
Acrylic acid ethyl ester	100	20	-
Adipic acid, aqueous	saturated	20	r
	saturated	60	-
Aluminium chloride	diluted	40	r
	diluted	60	r
	saturated	60	r
Aluminium sulfate, aqueous	diluted	40	r
	diluted	60	r
	saturated	60	r
Alums, aqueous	diluted	40	r
	diluted	60	r
	saturated	60	r
Ammonia, gas	100	60	r
Ammonia, liquid	100	20	r
Ammonium chloride, aqueous	diluted	40	r
	diluted	60	r
	saturated	60	r
Ammonium Fluoride, aqueous	up to 20	20	r
	up to 20	60	r
Ammonium hydroxide	warm sat.	40	r
	warm sat.	60	r
Ammonium nitrate, aqueous	diluted	40	r
	diluted	60	r
	saturated	60	r
Ammonium sulfate, aqueous	diluted	40	r
	diluted	60	r
	saturated	60	r
Ammonium sulfide, aqueous	diluted	40	r
	diluted	60	r
	saturated	60	r

CHEMICAL	Concentr, %	Temp. °C	DrainPro PP
Aniline hydrochloride, aqueous	saturated	20	r
	saturated	60	r
Aniline, aqueous	saturated	20	r
	saturated	60	r
Aniline, pure	100	20	r
	100	60	r
Animal glue	custom. co	20	r
	custom. co	60	r
Anthraquinonesulfonic acid, aqueoususpension 30			r
Antiformin, aqueous	2	20	-
Antimony chloride, aqueous	90	20	r
Arsenic acid, aqueous	diluted	40	r
	diluted	60	r
	80	40 r	
	80	60 r	
Beef tallow emulsion, sulphonated	com. avail.	20	-
Beer	com. avail.	20	r
Beer colourinzg agent	com. avail.	60	r
Benzaldehyde, aqueous	0,1	60	-
Benzene	100	20	cr
Benzoic acid, aqueous	any	20	r
	any	40	r
	any	60	r
Bisulphite solution, w/SO	warm sat.	50	r
Bleaching liquour, containing 12.5 % active chlorine	usage conc.	40	-
	usage conc.	60	cr
Borax, aqueous	diluted	40	r
	diluted	60	r
	saturated	60	r
Boric acid, aqueous	diluted	40	r
	diluted	60	r
	saturated	60	r
Brandy	com. avail.	20	r
Bromine fumes	minimal	20	nr
Bromine, liquid	100	20	nr
Butadiene	100	60	-
Butane, gaseous	50	20	r
Butanediol	up to 100	20	-
Butanediol, aqueous	up to 10	20	r
	up to 10	40	r
	up to 10	60	r
Butanol	up to 100	20	r
	up to 100	40	r
	up to 100	60	cr
Butyl acetate	100	20	cr
Cider	com. avail.	20	r

TABLE LEGEND r=resistant | cr=conditionally resistant | nr=not resistant | -=not tested

CHEMICAL RESISTANCE CHART

CHEMICAL	Concentr, %	Temp. °C	DrainPro PP
Citric acid, aqueous	up to 10	40	r
	up to 10	60	r
	saturated	60	r
Clophene	com. avail.	20	-
	com. avail.	60	-
Coconut fat alcohol	100	20	r
	100	60	cr
Copper Fluoride, aqueous	2	50	r
Copper sulfate, aqueous	diluted	40	r
	diluted	60	r
	saturated	60	r
Cresol, aqueous	up to 90	45	-
Crotonaldehyde	100	20	r
Cyclohexanol	100	20	r
Cyclohexanone	100	20	r
Cyclohexanone	100	20	r
Densodrin W	com. avail.	60	-
Dextrin, aqueous	saturated	20	r
	18	60	r
Diethylether	100	20	cr
Diglycol acid, aqueous	30	60	r
	saturated	20	r
Dimethyl sulfate, aqueous	up to 50	20	r
	up to 50	40	r
	100	40	-
	100	60	-
Dimethylamine, liquid	100	30	-
Disulfuric acid	10	20	nr
Ethanol (fermentation mash)	common	40	r
	common	60	-
Ethanol, aqueous	any	20	r
	96	60	r
Ethanol, denatured (with 2 % toluene)	96	20	cr
		20	r
Ethanol+ acetic acid (fermentation mash)	common	20	r
		20	r
Ethyl acetate	100	20	cr
	100	60	nr
Ethylene chloride	100	20	nr
Ethylene oxide, liquid	100	20	-
Exhaust gas, w/COH	any	60	r
Exhaust gas, w/ HF	traces	60	r
Exhaust gas, w/ NOX	traces	60	r
	higher	60	-
Exhaust gases, w/S O7H	lower	20	-
	higher	20	nr
Exhaust gases, w/SOH, moist	any	60	r
Exhaust gases, w/ HCl	any	60	r
Exhaust gases, w/ SO	lower	60	r

CHEMICAL	Concentr, %	Temp. °C	DrainPro PP
	50	50	-
Fatty acids	100	60	cr
Ferric chloride, aqueous	up to 10	40	r
	up to 10	60	r
	saturated	60	r
Fertilizer salts, aqueous	up to 10	40	r
	up to 10	60	r
	saturated	60	r
Fluorsilicic acid, aqueous	up to 32	60	-
Formaldehyde, aqueous	diluted	40	r
	diluted	60	r
	40	30	r
Formic acid	100	20	r
	100	60	cr
Formic acid, aqueous	up to 50	40	r
	50	60	r
Frigen	100	20	cr
Fruit pulp	custom. conc	20	r
Glucose, aqueous	saturated	20	r
	saturated	60	r
Glycerine, aqueous	any	60	r
Glycine, aqueous	10	40	r
Glycol, aqueous	com. avail.	60	r
Glycolic acid, aqueous	37	20	r
Hexantriol	com. avail.	60	r
Hydrobromic acid, aqueous	up to 10	40	r
	up to 10	60	r
	48	60	r
Hydrochloric acid, aqueous	up to 30	40	r
	up to 30	60	r
	over 30	20	r
	over 30	60	r
Hydrofluoric acid, aqueous	up to 40	20	r
	40	60	r
	60	20	r
	70	20	r
Hydrogen	100	60	r
Hydrogen peroxide, aqueous	up to 30	20	r
	up to 20	50	r
Hydrogen phosphide	100	20	-
Hydrogen sulfide, dry	100	60	r
Hydrogen sulfide, aqueous	warm sat.	40	r
	warm sat.	60	r
Hydrosulfite, aqueous	up to 10	40	r
	up to 10	60	r
Hydroxylamine sulfate, aqueous	up to 12	35	r
Lactic acid, aqueous	up to 10	40	r
	up to 10	60	r
	90	60	r

CHEMICAL RESISTANCE CHART

CHEMICAL	Concentr. %	Temp. °C	DrainPro PP
Lead acetate, aqueous	warm sat.	50	r
Butylene, liquid	100	20	-
Butylphenol	100	20	r
Butynediol	up to 100	40	-
Butyric acid, aqueous	20	20	r
	concentr.	20	r
Calcium chloride, aqueous	diluted	40	r
	diluted	60	r
	saturated	60 r	
Calcium nitrate, aqueous	50	40	r
Carbolinum, aqueous	usage conc.	20	-
Carbon dioxide, aqueous under 8 atmospheric pressures	saturated	20	-
Carbon dioxide, dry	100	60	r
Carbon dioxide, moist	any	40	r
	any	60	r
Carbon disulfide	100	20	cr
Carbon tetrachloride, technical	100	20	nr
Caustic potash solution, aqueous			
	up to 40	40	r
	up to 40	60	r
	50/60	60	r
Caustic soda, aqueous	up to 40	40	r
	up to 40	60	r
	50/60	60	r
Chloramine, aqueous	diluted	20	-
Chloric acid, aqueous	1	40	-
	1	60	-
	10	40	-
	10	60	-
	20	40	-
	20	60	-
Chlorine water	saturated	20	cr
Chlorine, gaseous, dry	100	20	nr
Chlorine, gaseous, moist	0,5	20	nr
	1	20	nr
	5	20	nr
Chlormethyl	100	20	-
Chloroacetic acid (mono)	100	40	r
	100	60	-
Chloroacetic acid (mono) aqueous	85	20	r
Chlorosulfonic acid	100	20	nr
Chromic acid, aqueous	up to 50	40	-
	up to 50	60	cr
Chromic acid/Sulphuric acid/Water	50/15/35	40	nr
	50/15/35	60	nr
	diluted	40	r

CHEMICAL	Concentr. %	Temp. °C	DrainPro PP
	diluted	60	r
	saturated	60	r
Lead tetraethyl	100	20	r
Magnesium chloride, aqueous	diluted	40	r
	diluted	60	r
	saturated	60 r	
Magnesium sulfate, aqueous	diluted	40	r
	diluted	60	r
	saturated	60	r
Maleic acid, aqueous	saturated	40	r
	saturated	60	r
	35	40 r	
Malic acid, aqueous	1	20	r
Mersol D	custom. conc	40.	-
Methanol	100	40	r
	100	60	r
Methyl amine	32	20	r
Methylene chloride	100	20	nr
Milk	com. avail.	20	r
Mixed acid (Sulfuric acid/Nitric acid/Water)	48/49/3	20	nr
	48/49/3	40	nr
	50/50/0	20	nr
	50/50/0	40	nr
	10/20/70	50	cr
	10/87/3	20	nr
	50/31/19	30	nr
Molasses	custom. conc	20	r
	custom. conc	60	r
Molasses wort	custom. conc	60	r
Mowilith D	com. avail.	20	-
Nekal, BX, aqueous	diluted	40	-
	diluted	60	-
Nickel sulfate, aqueous	diluted	40	r
	diluted	60	r
	saturated	60 r	
Nicotine compounds, aqueous	usage conc.	20	-
Nicotine, aqueous	usage conc.	20	-
Nitric acid, aqueous	up to 30	50	r
	30/50	50	nr
	98	20	nr
	98	60	nr
Nitrous gasses	concentr.	20	r
	concentr.	60	-
Oils and greases	com. avail.	60	cr
Oleic acid	com. avail.	60	cr
Oleum vapour	lower	20	cr
	higher	20	nr
Oxalic acid, aqueous	diluted	40	r
	diluted	60	r

CHEMICAL RESISTANCE CHART

CHEMICAL	Concentr, %	Temp. °C	DrainPro PP
	saturated	60	r
Oxygen	any	60	-
Ozone	100	20	cr
	10	30	r
Palm kernel oil acid	100	60	-
Paraffin emulsions	com. avail.	20	-
	com. avail.	40	-
Perchloric acid, aqueous	up to 10	40	r
	up to 10	60	r
	saturated	60	-
Petrol	100	60	nr
Petrol-benzene mixture	80/20	20	cr
Phenol, aqueous	up to 90	45	r
	1	20	-
Phenylhydrazine	100	20	cr
	100	60	-
Phenylhydrazine hydrochloride, aqueous	saturated	20	-
	saturated	60	-
Phosgene, aqueous	100	20	nr
Phosgene, gaseous	100	20	cr
	100	60	cr
Phosphoric acid, aqueous	up to 30	40	r
	up to 30	60	r
	40	60	r
	80	20 r	
	80	60 r	
Phosphorous pentoxide	100	20	r
Phosphorous trichloride	100	20	r
Photographic developers	com. avail.	40	r
Photographic emulsions	any	40	-
Photographic fixers	com. avail.	40	r
Picric acid, aqueous	1	20	r
Potash, aqueous	saturated	40	-
Potassium borate, aqueous	1	40	r
	1	60	r
Potassium bromate, aqueous	up to 10	40	r
	up to 10	60	r
Potassium bromide, aqueous	diluted	40	r
	diluted	60	r
	saturated	60	r
Potassium chlorate, aqueous	1	40	r
	1	60	r
Potassium chloride, aqueous	diluted	40	r
	diluted	60	r
	saturated	60	r
Potassium chromate, aqueous	40	20	r
Potassium cyanide, aqueous	up to 10	40	r
	up to 10	60	r

CHEMICAL	Concentr, %	Temp. °C	DrainPro PP
	saturated	60	r
Potassium dichromate, aqueous	40	20	r
Potassium ferrocyanide	diluted	40	r
Potassium ferrocyanide, aqueous	diluted	60	r
	saturated	60	r
Potassium nitrate, aqueous	diluted	40	r
	diluted	60	r
	saturated	60	r
Potassium permanganate, aqueous	up to 6	20	r
	up to 6	40	r
	up to 6	60	r
	up to 18	40	-
Potassium persulfate, aqueous	diluted	40	r
	diluted	60	r
	saturated	40 r	
	saturated	60 r	
Propane, gaseous	100	20	-
Propane, liquid	100	20	-
Propargyl alcohol, aqueous	7	60	r
Pure acetic acid	100	20	r
	100	40	r
Ramasite	com. avail.	20	-
	com. avail.	40	-
Roaster gases, dry	any	60	r
Seawater	-	40	r
	-	60	r
Silicic acid, aqueous	any	60	r
Silver nitrate, aqueous	up to 8	40	r
	up to 8	60	r
Soap solution, aqueous	concentrated	20	r
	concentrated	60	r
Soda, aqueous	diluted	40	r
	diluted	60	r
	saturated	60	r
Sodium benzoate, aqueous	up to 10	40	r
	up to 10	60	r
	36	60	r
Sodium chlorate, aqueous	up to 10	40	r
	up to 10	60	r
	saturated	60	r
Sodium chlorite, aqueous	50	20	r
	diluted	60	nr
Sodium hydrosulfate, aqueous	diluted	40	r
	diluted	60	r
	saturated	60	r
Sodium hypochlorite, aqueous	diluted	20	r
Sodium sulfide, aqueous	diluted	40	r

CHEMICAL RESISTANCE CHART

CHEMICAL	Concentr, %	Temp. °C	DrainPro PP
	diluted	60	r
	saturated	60	r
Spirits	com. avail.	20	r
Starch syrup	custom. conc	60	r
Starch, aqueous	any	40	r
	any	60	r
Stearic acid	100	60	cr
Sulphur dioxide, aqueous under 8 atmospheric pressures	saturated	20	-
Sulphur dioxide, liquid	100	-10	-
	100	20	r
	100	60	r
Sulphur dioxide, moist and aqueous any	40	r	
	50	50	r
	any	60	r
Sulphur dioxide, dry	any	60	r
Sulphuric acid, aqueous	up to 40	40	r
	up to 40	60	r
	70	20	r
	70	60	cr
	80-90	40	cr
	96	20	r
	96	60	nr
Table salt, aqueous	diluted	40	r
	diluted	60	r
	saturated	60 r	
Tallow	100	20	r
	100	60	r
Tanigan extra A, aqueous	any	20	-
Tanigan extra B, aqueous	any	20	-
Tanigan extra D, aqueous	saturated	40	-
	saturated	60	-
Tanigan F, aqueous	saturated	60	-
Tanigan U, aqueous	saturated	40	-
	saturated	60	-
Tanning extracts, cellul.	common	20	r

CHEMICAL	Concentr, %	Temp. °C	DrainPro PP
Tanning extracts, natural	common	20	r
Tartaric acid, aqueous	up to 10	40	r
	up to 10	60	r
	saturated	60	r
Thionyl chloride	100	20	nr
Tin (II) chloride, aqueous	diluted	40	r
	diluted	60	r
	saturated	60	r
Toluene	100	20	nr
Trichloroethylene	100	20	nr
Triethanolamine	100	20	r
Trilone	com. avail.	60	-
Trimethylolpropane, aqueous	up to 10	40	-
	up to 10	60	-
	com. avail.	40	r
	com. avail.	60	r
Urea, aqueous	up to 10	40	r
	up to 10	60	r
	33	60	r
Urine	normal	40	r
	normal	60	r
Vinegar (wine vinegar)	com. avail.	40	r
	com. avail.	50	r
	com. avail.	60	r
Vinyl acetate	100	20	r
Water	100		r
	100		r
Wax alcohol	100	60	cr
Wine, red and white	com. avail.	20	r
Xylene	100	20	nr
Yeast wort	custom. con	40	r
	custom. con	60	r
Zinc chloride, aqueous	diluted	40	r
	diluted	60	r
	saturated	60	r
Zinc sulphate, aqueous	diluted	40	r
	diluted	60	r
	saturated	60	r



*A consumer validated
Superbrand in piping
category for
consecutive 4 years*



*India's Most Trusted
Pipe Brand based on
TRA's Brand Trust
Report for the 5th time*

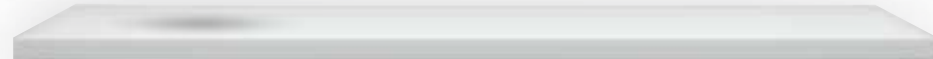

Power of Desire



*India's Most Desired
Brand based on
TRA's Brand Trust
Report 2022*

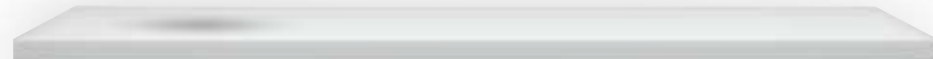

CIN NO: L25200GJ1996PLC029134

Registered & Corporate Office: Astral Limited

207/1, 'Astral House', B/h Rajpath Club, Off S. G. Highway, Ahmedabad - 380059.

Ph: +91-79 6621 2000 | Fax: +91-79 6621 2121 | E-mail: info@astralltd.com | Website: www.astralltd.com

For Export Inquiries: export@astralltd.com



**ASTRAL TOLL FREE
1800 233 7957**

Please get in touch with us between
10 AM to 6 PM between Monday to Friday
and the last Saturday of the month.
We will remain closed on Public Holidays.

SC: PR07000048
ADP/PC/002
REV:05/23