



# LOW NOISE DRAINAGE SYSTEM, REDEFINED

## PRODUCT CATALOGUE



# CONTENTS



**03**

ABOUT ASTRAL

**04**

INNOVATION &  
RECOGNITIONS

**05**

MARKETING  
NETWORK

**06**

CERTIFICATION

**08**

WARRANTY

**09**

SYSTEM  
DESCRIPTION

**10**

FIELDS OF  
APPLICATION

**12**

PIPE STRUCTURE  
FITTINGS  
& FEATURES

**13**

KEY  
PROPERTIES

**14**

WHAT  
IS NOISE?

**16**

SOUND-INSULATION  
REQUIREMENTS

**17**

SOUND INSULATION  
BY ASTRAL SILENCIO

**19**

ACOUSTIC  
PLUMBING DESIGN

**20**

FIRE BEHAVIOUR  
CLASSIFICATION

**21**

FIRE RESISTANCE  
CLASSIFICATION

**22**

TYPES OF  
INSTALLATION

**24**

TECHNICAL  
SPECIFICATION

**26**

PRODUCT  
RANGE

**36**

INSTALLATION  
PROCEDURE

**38**

FIXATION

**40**

ARRANGEMENTS  
OF THE BRACKETS

**41**

SUPPORT SPACING  
DISTANCES

**42**

LOADING,  
UNLOADING,  
STORAGE &  
OUTDOOR EXPOSURE

**43**

CLEANING AND  
MAINTENANCE

**44**

CHEMICAL  
RESISTANCE CHART

**50**

CLIENT LIST

**1<sup>st</sup> TO  
INTRODUCE  
CPVC  
IN INDIA**

**1<sup>st</sup> TO  
INTRODUCE  
UPVC LEAD  
FREE PIPES  
IN INDIA**

**1<sup>st</sup> TO  
INTRODUCE  
LOW NOISE  
PP DRAINAGE  
PIPES IN INDIA**

**1<sup>st</sup> TO  
INTRODUCE  
FOAMED PVC  
DRAINAGE  
PIPES IN INDIA**



**1<sup>st</sup> TO  
INTRODUCE  
LEAD FREE  
COLUMN PIPES  
IN INDIA**

**1<sup>st</sup> TO  
INTRODUCE  
POLYMER BASED  
INDUSTRIAL  
PIPING SYSTEM  
IN INDIA**

**1<sup>st</sup> TO  
INTRODUCE  
NSF APPROVED  
SOLVENT  
CEMENT  
IN INDIA**

**1<sup>st</sup> TO  
INTRODUCE  
CPVC PIPING FOR  
AUTOMATIC  
FIRE SPRINKLER  
SYSTEM IN INDIA**

# ASTRAL, INDIA'S PROGRESSIVE BUILDING MATERIALS COMPANY

Established in 1996 with the aim to manufacture best-in-globe plastic piping systems, Astral Pipes fulfils emerging piping needs of millions of houses and adds extra mileage to India's developing real estate fraternity with the hallmark of unbeaten quality and innovative piping solutions. Keeping itself ahead of the technology curve, Astral has always been a front runner in the piping category by bringing innovation and getting rid of old, primitive and ineffective plumbing methods. Bringing CPVC in India, and pioneering in this technology, have set Astral apart and its highest quality enabled it to obtain NSF approval for its CPVC pipes and fittings. Astral went beyond the category codes by launching many industry firsts, like launching India's first lead-free uPVC pipes for plumbing as well as for stream water, just to name a few.

Astral Pipes offers the widest product range across this category when it comes to product applications. Astral Pipes is equipped with production facilities at Santej and Dholka in Gujarat, Hosur in Tamil Nadu, Ghiloth in Rajasthan, Sangli & Aurangabad in Maharashtra, Cuttack in Odisha and Sitarganj in Uttarakhand to manufacture plumbing systems, drainage systems, agriculture systems, fire sprinkler piping systems, industrial piping and electrical conduit pipes with all kinds of necessary fittings.

Astral Pipes' Infrastructure division offers a comprehensive product range including corrugated piping for drainage and cables, polyolefin cable channels, sewage treatment plants, plastic sheathing ducts, suction hoses, and sub-surface drainage systems. This range helps Astral to establish a strong foothold in infrastructure and agriculture sector in the constantly evolving business of piping.

In 2014, Astral forayed into the adhesives category by acquiring UK-based Seal It Services Ltd. and Kanpur based Resinova Chemie Ltd., which manufacture adhesives, sealants and construction chemicals. With five manufacturing facilities now in this business segment, Astral has strengthened its presence in the category and made rapid inroads.

In the year 2020, Astral has expanded its product portfolio and entered into the Water Tanks Segment. The water tank segment is an expanded domain of plumbing and water supply with a huge nationwide potential. Astral Pipes manufactures water tanks from its Santej, Aurangabad, Cuttack, Hosur & Ghiloth manufacturing facilities. A wide range of water storage tanks has helped Astral to become a versatile player in the industry.

Extending the product portfolio further, in the year 2022 Astral forayed into the categories of Faucets and Sanitaryware, followed by acquisition of Bangalore based Gem Paints to enter in the Paints category. This expansion will help Astral march firmly towards becoming a holistic building materials company.

## ADHESIVES

EPOXY ADHESIVES & PUTTY  
SILICONE SEALANTS  
CONSTRUCTION CHEMICALS **PVA**  
CYANOACRYLATE **SOLVENT CEMENTS**  
**TAPES** POLYMERIC FILLING COMPOUND  
ANAEROBIC ADHESIVES  
INDUSTRIAL ADHESIVES  
**INSTANT HAND SANITIZER**  
SURFACE CLEANING PRODUCTS

## PIPING

PLUMBING PIPES & FITTINGS  
**CPVC, PVC & PEX**  
SEWERAGE DRAINAGE PIPES & FITTINGS  
**AGRICULTURE** PIPES & FITTINGS  
**INDUSTRIAL PIPES & FITTINGS**  
FIRE SPRINKLERS PIPES & FITTINGS  
**CONDUIT & CABLE** PROTECTION  
ANCILLARY PRODUCTS  
**URBAN** INFRASTRUCTURE

## WATER TANKS

## PAINTS

## DUCTING

## FAUCETS

## SANITARYWARE







# INNOVATION & RECOGNITIONS

- First to introduce CPVC piping system in India (1999)
- First to launch lead free uPVC piping system in India (2004)
- Corp Excel- National SME Excellence Award (2006)
- First to get NSF Certification for CPVC piping system in India (2007)
- First to launch lead-free uPVC column pipes in India (2012)
- Enterprising Entrepreneur of the year (2012-13)
- Business Standard Star SME of the year (2013)
- Inc. India Innovative 100 for Smart Innovation under category of 'Technology' (2013)
- India's Most Promising Brand Award (2014)
- Value Creator Award during the first ever Fortune India Next 500 (2015)
- India's Most Trusted Pipe Brand Award (2016, 2019 & 2020)
- ET Inspiring Business Leaders of India Award (2016)
- India's Most Attractive Pipe Brand Award (2016)
- Fortune India 500 Company (2016)
- Consumer Validated Superbrands India (2017, 2019 & 2021)
- India's Most Desired Brand based on TRA's Brand Trust Report (2021)



# MARKETING NETWORK

Astral has a marketing network of more than 800 distributors and 30,000 dealers spread all over India with branch offices at Mumbai, Pune, Delhi, Bengaluru, Chennai, Hyderabad, Jaipur, Lucknow and Kochi. Apart from that Astral has its own warehouses at Vijaywada, Hyderabad, Delhi, Kolhapur, Kolkata, Nagpur, Indore, Patna, Varanasi, Jaipur & Hosur to deliver the material as quick as possible. More than 400 techno marketing professionals and administrative personnel are on the board to coordinate with architects, plumbing contractors and plumbers to utilize the best plumbing techniques and to get the best from the products.

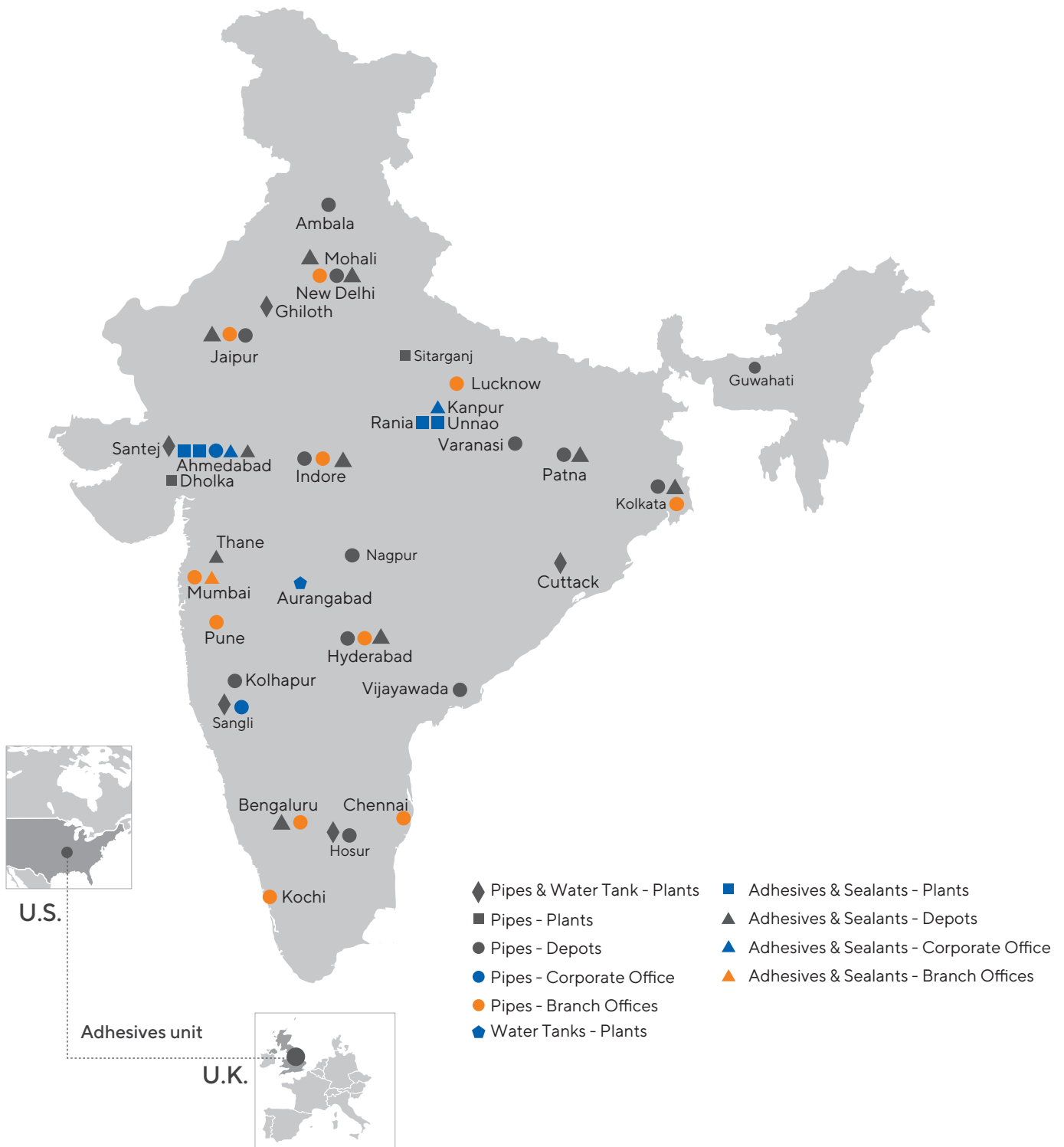

# CERTIFICATION

**Deutsches Institut für Bautechnik** **DIBt**

Eine vom Bund und den Ländern gemeinsam getragene Anstalt des öffentlichen Rechts

**Zulassungs- und Genehmigungsstelle für Bauprodukte und Bauarten**

Datum: 07.02.2023 III 53-1.42-1-12/21

---

**Allgemeine bauaufsichtliche Zulassung**

**Zulassungsnummer:** Z-42.1-595

**Geltungsdauer:** vom 7. Februar 2023 bis 7. Februar 2028

**Antragsteller:** **ASTRAL LIMITED**  
"ASTRAL HOUSE" 207/1, Bh. Rajpath Club AHMEDABAD 380059 INDIEN

**Zulassungsgegenstand:** Abwasserrohre und Formstücke mit der Bezeichnung "Silencio" aus mineralverstärktem PP in den Nennweiten DN 50 bis DN 200

Der oben genannte Zulassungsgegenstand wird hiermit allgemein bauaufsichtlich zugelassen. Dieser Bescheid umfasst neun Seiten und vier Anlagen.

**DIBt**

DIBt | Referenznummer: 24 81 01 | 12028 Berlin | Tel.: +49 30 20203-0 | Fax: +49 30 20203-100 | E-Mail: info@dibt.de | www.dibt.de

**ZERTIFIKAT SKZ** **SKZ** SKZ SYSTEM climate-neutral Certification Body

**CONFORMITY CERTIFICATE**

Reg.-No. 7891

Herewith we confirm in accordance with article 18 and article 21 of the Bavarian Building Regulations (BayBO) as published on 14 August 2007 (GVBl. S. 588, BayRS 2132-1-III), updated by Article 2 of the Act of 10 February 2023 (GVBl. S. 22) that the building products

**Waste water pipes and fittings made of mineral filled PP in the nominal sizes DN 50 to DN 200 with the trade name "Silencio"**

of the producer **Astral Limited** 207/1 Astral House B/H. Rajpath Club, Off S.G. Highway AHMEDABAD – 380 059 (GUJARAT) INDIA

production plant **Astral Limited** (Block no. 1200, 1210, 1212, 1253, 1264) Santaj, Narnand Road Village: SANTEJ, TA: KALOL, DIST. GANDHINAGAR INDIA

according to the results of the internal production control and the third-party control carried out by the testing institute, recognized under building regulations.

**SKZ - Testing GmbH**  
Friedrich-Begius-Ring 22  
97076 Würzburg  
Germany

comply with the requirements of the standards

the national technical approval no.: **Z-42.1-595 of 07 February 2023**  
valid until: **07 February 2028**

Würzburg, 12 April 2023

**SKZ**  
Dipl.-Ing. Hans-Peter Kötter  
Head of Certification Body

The original language of this certificate is German. In case of doubt, the German version is obligatory.  
SKZ - Testing GmbH, Friedrich-Begius-Ring 22, 97076 Würzburg, Germany. Tel. +49 931 4164-0, info@skz.de, www.skz.de

**ASTRAL LIMITED**

**ASTRAL PIPES**

REGISTERED & CORPORATE OFFICE: 207/1, "ASTRAL HOUSE", B/H. RAJPATH CLUB, OFF. S.G.HIGHWAY, AHMEDABAD – 380 059, GUJARAT, INDIA.

This is a multi-site certificate, additional site(s) are listed on the next page(s)

*Bureau Veritas Certification Holding SAS – UK Branch certifies that the Management System of the above Organisation has been audited and found to be in accordance with the requirements of the Management System Standards detailed below.*

**Standards**

**ISO 14001:2015 & ISO 45001:2018**

*Scope of certification*

**MANUFACTURE, MANAGEMENT, MARKETING AND DESPATCH OF**

- CPVC PIPES AND FITTINGS FOR HOT/COLD WATER PLUMBING SYSTEMS (CPVC-PRO), AUTOMATIC FIRE SPRINKLER APPLICATIONS (FIRE-PRO), INDUSTRIAL PIPING SYSTEMS (CHEM-PRO) AND CPVC BALL VALVES
- UPVC PIPES AND FITTINGS FOR PRESSURE, NON-PRESSURE, AGRICULTURAL AND WATER TRANSPORT SYSTEM (AQUASAFE), ELECTRICAL CONDUIT APPLICATIONS (WIREGUARD), INDUSTRIAL PIPING SYSTEMS (AQUARISH), SWR (SOIL WASTE AND RAINWATER) SYSTEMS (DRAINMASTER) AND UPVC COLUMN PIPES, SCREEN AND CASING PIPES FOR BORE WELLS (BOREWELL, CASEWELL) AND UPVC BALL VALVES
- UPVC FOAM CORE PIPES FOR DWV (DRAIN WASTE AND VENT) AND UNDERGROUND SYSTEMS (FOAMCORE, DWV AND USE)
- PP SILENCIO PIPES AND FITTINGS FOR APPLICATION ON BUILDING STRUCTURES AND UNDERGROUND NEAR THE BUILDING STRUCTURES (SILENCIO)
- PEPP UNDERGROUND INSPECTION CHAMBERS AND MAN-HOLES (DRAINHULK)
- LEAD-FREE UPVC PIPES & FITTINGS FOR PLUMBING SYSTEMS (AQUARIUS)
- MULTILAYER CPVC COMPOSITE PIPES (MULTI-PRO)
- UPVC LEAD-FREE PLUMBING PIPES FOR TRANSFER OF COLD AND NON-POTABLE PRESSURIZED TREATED WATER (ECO-PRO)
- PE ROTATIONAL Moulded WATER STORAGE TANKS (2 LAYER-SYLIO 3 LAYER-VITO 4 LAYER-CLEO / 2 & 3 LAYER-SARTIA)
- PE DRAINPRO PIPES AND FITTINGS FOR APPLICATION ON BUILDING STRUCTURES AND UNDERGROUND NEAR THE BUILDING STRUCTURES (DRAINPRO)
- PE BLOW Moulded WATER STORAGE TANKS (3 LAYER – OPTA)

Original cycle start date: 14 May 2020  
Expiry date of previous cycle: 13 May 2023  
Recertification Audit date: 13 April 2023  
Recertification cycle start date: 09 June 2023

Subject to the continued satisfactory operation of the Organisation's Management System, this certificate is valid until: **13 May 2026**

Certificate No. **IND.23.5572/IMU** Version: 1 Issue date: **09 June 2023**

For certificate authenticity, click here <https://certcheck.ukas.com>

ISO 14001	IND43721
ISO 45001	IND43722

Signed on behalf of BVCH SAS UK Branch  
**Jagdish N. MANAN**  
Director – CERTIFICATION, South Asia  
Commodities, Industry & Facilities Division

Certification body address: 5th Floor, 66 Prescot Street, London, E1 6NG, United Kingdom.

Local office: Bureau Veritas (India) Private Limited (Certification Business)  
72 Business Park, Marol Industrial Area, MIDC Cross Road "C",  
Andheri (East), Mumbai – 400 093, India

Pg. 1 of 3

Further clarifications regarding the scope of this certificate and the applicability of the management system requirements may be obtained by consulting the organization. To check this certificate validity please call + 91 22 6274 2000.

**ASTRAL LIMITED**

**ASTRAL PIPES**

HEAD OFFICE: 207/1, "ASTRAL HOUSE", OPP. SATYAM CORPORATE SQUARE, B/H. RAJPATH CLUB, OFF. S.G.HIGHWAY, AHMEDABAD – 380 059, GUJARAT, INDIA.

This is a multi-site certificate, additional site(s) are listed on the next page(s)

*Bureau Veritas Certification Holding SAS – UK Branch certifies that the Management System of the above organization has been audited and found to be in accordance with the requirements of the Management System Standard detailed below.*

**Standard**

**ISO 9001:2015**

*Scope of certification*

**MANAGEMENT & MARKETING OF:**

- CPVC PIPES AND FITTINGS FOR HOT/COLD WATER PLUMBING SYSTEMS (CPVC-PRO), AUTOMATIC FIRE SPRINKLER APPLICATIONS (FIRE-PRO), INDUSTRIAL PIPING SYSTEMS (CHEM-PRO) AND CPVC BALL VALVES
- UPVC PIPES AND FITTINGS FOR PRESSURE, NON-PRESSURE, AGRICULTURAL AND WATER TRANSPORT SYSTEM (AQUASAFE), ELECTRICAL CONDUIT APPLICATIONS (WIREGUARD), INDUSTRIAL PIPING SYSTEMS (AQUARISH), SWR (SOIL WASTE AND RAIN WATER) SYSTEMS (DRAINMASTER) AND UPVC COLUMN PIPES, SCREEN AND CASING PIPES FOR BORE WELLS (BOREWELL, CASEWELL) AND UPVC BALL VALVES
- UPVC FOAM CORE PIPES FOR DWV (DRAIN WASTE AND VENT) AND UNDERGROUND DRAINAGE SYSTEMS (FOAMCORE, DWV & USE)
- PP SILENCIO PIPES AND FITTINGS FOR APPLICATION ON BUILDING STRUCTURES AND UNDERGROUND NEAR THE BUILDING STRUCTURES (SILENCIO)
- PEPP UNDERGROUND INSPECTION CHAMBERS AND MAN-HOLES (DRAINHULK)
- LEAD-FREE UPVC PIPES FOR PLUMBING SYSTEMS (AQUARIUS)
- PEPP STRUCTURED WALL DWV (DOUBLE WALLED CORRUGATED) PIPING SYSTEM FOR NON-PRESSURE DRAINAGE AND SEWERAGE APPLICATIONS (SILEX)
- MULTILAYER CPVC COMPOSITE PIPES (MULTI-PRO)
- UPVC LEAD-FREE PLUMBING PIPES FOR TRANSFER OF COLD AND NON-POTABLE PRESSURIZED TREATED WATER (ECO-PRO)
- PE ROTATIONAL Moulded WATER STORAGE TANKS (2 LAYER-SYLIO 3 LAYER-VITO 4 LAYER-CLEO)
- CONDUIT PIPES AND FITTINGS FOR UNDERGROUND CABLE MANAGEMENT SYSTEM (TELEX)
- PE PIPES FOR WATER SUPPLY (BORING) (SARTIA & VARADAN)
- UPVC SWR (SINGLE WALLED CORRUGATED) PIPES AND FITTINGS FOR SUB-SURFACE DRAINAGE SYSTEM (VARADAN & GEORX)
- UPVC DRINKABLE AND DRINKABLE FOR TUNNEL DRAINAGE, ROAD DRAINAGE AND SIMILAR APPLICATIONS (AQUAREX)
- PE POLYESTER CABLE CHANNEL FOR SIGNAL / COMMUNICATION POWER CABLES (MELTITE)
- PE / PP DUCTS AND FITTINGS FOR INTERNAL BONDED POST TENSIONING OF TENDONS IN PRE-STRESSED CONCRETE (PLUS-STREX & PRE-STREX)

Original cycle start date: 11 February 2023  
Expiry date of previous cycle: 10 February 2021  
Recertification Audit date: 26 December 2020  
Recertification cycle start date: 16 January 2021

Subject to the continued satisfactory operation of the organization's Management System, this certificate expires on: **10 February 2024**

Certificate No. **IND.21.6008/CMU** Version: 3 Revision date: **14 February 2022**

For certificate authenticity, click here <https://certcheck.ukas.com>

ISO 9001	IND43721
----------	----------

Signed on behalf of BVCH SAS UK Branch  
**Jagdish N. MANAN**  
Head – CERTIFICATION, South Asia  
Commodities, Industry & Facilities Division

Certification body address: 5th Floor, 66 Prescot Street, London, E1 6NG, United Kingdom.

Local office: Bureau Veritas (India) Private Limited (Certification Business)  
72 Business Park, Marol Industrial Area, MIDC Cross Road "C",  
Andheri (East), Mumbai – 400 093, India

Pg. 1 of 3

Further clarifications regarding the scope of this certificate and the applicability of the management system requirements may be obtained by consulting the organization. To check this certificate validity please call + 91 22 6274 2000.



**IAPMO India Pvt. Ltd.**  
No.43, 4th Floor, PMR Tower, Hosur Road, Bangalore, Karnataka 560100

**CERTIFICATE OF LISTING**

**Licensee: ASTRAL LIMITED.**  
Address: 207/1, Astral House, B/H Rajpath Club, off. S.G. Highway, Ahmedabad, Gujarat -380059, India.  
File No: IN-1057 Product: Polypropylene (PP) DWV Pipes with mineral filled core and PP Fittings Void After: Feb 2024

**IDENTIFICATION:** The products (Polypropylene (PP) DWV Pipes with mineral filled core and PP Fittings) shall be permanently and legibly marked at length intervals of not more than 5 ft (1.5m) with manufacturer's name or trademark, nominal size, standard designation "IAPMO IGC 345", material (e.g., "PP", "PP-1F", "PP-M"), intended application "DWV", for pipe and fittings intended for butt fusion the MFR Class, and date, or date code of manufacture. PP pipe shall be marked in letters not less than 5mm (3/16 in) high, in a contrasting color, spaced at intervals of not more than 1.5m (5ft). Markings shall be permanent, legible and visible after installation. Products shall also bear the UPC-1™ certification mark.

**CHARACTERISTICS:** Products are DN 40 to DN 200 or 1-1/2 to 8 NPS polypropylene Drain, Waste and Vent (DWV) pipe with a mineral filled core and polypropylene fittings intended for use in commercial and residential applications. Products listed on this certificate have been tested by an IAPMO R&T recognized laboratory. This recognition has been granted based upon the laboratory's compliance to the applicable requirements of ISO/IEC 17025. Products are in compliance with the following standard(s): IGC 345-2019 25. All products shall bear the UPC-1™ certification mark.

**Tom Palkon**  
Executive Vice President and  
Chief Technical Services Officer  
The IAPMO Group.

This listing period is based upon the last date of the month indicated on the Effective Date and Void After Date shown above. Any change in material, manufacturing process, marking or design without having first obtained the approval of IAPMO India, or any evidence of non-compliance with applicable codes and standards or of inferior workmanship, may be deemed sufficient cause for revocation of this listing. Production of or reference to this form for advertising purposes may be made only by specific written permission of IAPMO India. Any unauthorized alteration of this certificate will be grounds for revocation of this listing.

**LEED**

**ASTRAL LIMITED**  
**SILENCIO PIPING DIVISION**

Santej, India

OPERATIONS AND MAINTENANCE EXISTING BUILDINGS

**PLATINUM**

November 2021

**Michael Ramangan**

**IAPMO RESEARCH AND TESTING, INC.**  
5001 E. Philadelphia Street, Ontario, CA 91761 • Phone (909) 472-4100 • Fax (909) 472-4244 • www.iapmort.org

**CERTIFICATE OF LISTING**

IAPMO Research and Testing, Inc. is a product certification body in which its product certification system includes inspection and testing of samples taken from the supplier's stock or from the market or a combination of both to verify compliance to the requirements of applicable codes and standards. This activity is coupled with periodic surveillance of the supplier's factory and/or warehouses as well as the assessment of the supplier's Quality Assurance System. This listing is subject to the conditions set forth in the characteristics below and is not to be construed as any recommendation, assurance or guarantee by IAPMO Research and Testing, Inc. of the product acceptance by Authorities Having Jurisdiction.

**ASTRAL LIMITED**  
207/1 ASTRAL HOUSE B/H RAJPATH CLUB OFF. S.G. HIGHWAY AHMEDABAD 380059, GUJARAT, INDIA

**Product:**  
Polypropylene (PP) DWV Pipe with a Mineral Filled Core and PP Fittings

Products are in compliance with the following code(s):  
N/A - CLASSIFIED  
(This is not a listing for code compliance)

Products are certified to the following standard(s):  
IGC 345-2020a

File Number: C-11533  
Effective Date: August 2019  
Void After: August 2024\*

**Tom Collins**  
Chairman, Product Certification Committee

**Chief Technical Services Officer**

\*This certificate is not evidence of current listing. To verify listing status, visit the IAPMO R&T Product Listing Directory at pld.iapmo.org  
This listing period is based upon the last date of the month indicated on the Effective Date and Void After Date shown above. Any change in material, manufacturing process, marking or design without having first obtained the approval of the Product Certification Committee, or any evidence of non-compliance with applicable codes and standards or of inferior workmanship, may be deemed sufficient cause for revocation of this listing. Production of or reference to this form for advertising purposes may be made only by specific written permission of IAPMO Research and Testing, Inc. Any alteration of this certificate could be grounds for revocation of the listing. This document shall be reproduced in its entirety.

**CII**  
Confederation of Indian Industry

**CII-Green Products and Services Council**

hereby certifies that  
**Astral Silencio PP Pipes and Fittings**  
(GPASL139001)

Manufactured by Astral Limited at Santej, Ahmedabad, Gujarat  
meets the requirements of GreenPro Ecolabel and qualifies as Green Product.

This certification is valid till **December 2023**

**Jamshyd N Godrej**  
Chairman, CII-Green GBC

**Parulbhan R**  
Chairman, CII Green Product & Services Council

**K S Venkatagiri**  
Executive Director, CII-Green GBC

**CII**  
Confederation of Indian Industry

**CII - Sohrabji Godrej Green Business Centre**

hereby certifies that  
**Astral Limited (Silencio Division)**  
Santej, Gujarat

has successfully achieved the standards as required for  
the following level of certification under the  
GreenCo - Green Company Rating System  
which is valid for a period of 3 years

**GreenCo Gold**

Issue Date: 17-07-2021 Expiry Date: 16-07-2024

**Jamshyd N Godrej**  
Chairman  
CII-Godrej GBC

**Pradeep Bhargava**  
Chairman  
GreenCo Rating System

**L S Ganapati**  
Chairman  
GreenCo Assessor Panel

**K S Venkatagiri**  
Executive Director  
CII-Godrej GBC

# WARRANTY

## VALID FOR THE FOLLOWING AREAS OF APPLICATION:

- Noise-insulated above-ground drainage
- Highly noise-insulated above-ground drainage

In addition to any legal warranty and damage claims, upon the agreement of Astral Pipes general terms of business, the company undertakes the following:

## WARRANTY:

Astral Ltd. hereby warrants the performance of its high-quality Silencio Piping system. The warranty period shall extend up to 10 years from the date of manufacture for all the standard elements mentioned in this catalogue.

### THIS LIABILITY ENCOMPASSES:

1. Free delivery to the place of employment of the replacement parts required for the repair of the damage.
2. Necessary removal and installation costs, including the expenses incurred for the restoration of the object to its original condition, up to a sum of USD 25000.

Pursuant to this declaration Astral provides this Warranty when,

1. Laying was completed by trained personnel from a licensed sanitary plumbing company in connection with installation as contractually intended and all the technical regulations valid at the time of completion were observed.
2. Only Astral original parts were employed and that these were not combined with products of any other origin.
3. The cause of damage did not relate to parts subject to natural wear and tear, external mechanical damage, or other external influences on the product.
4. It can be proven that at the time of laying all the current storage, laying, installation and application stipulations were observed in full.
5. All the measures necessary for damage minimization were initiated immediately.
6. The occurrence of damage was reported to Astral without delay and under all circumstances within 10 days of the identification of the damage, complete with information concerning the related facts and circumstances.
7. Prior to repair work, Astral is given an opportunity to determine and appraise the damage itself or through a third party.
8. All the parts relating to the claim are kept for the investigation of the damage occurrence and are provided to Astral upon request.
9. The production and installation dates can be evidenced in the appropriate form.



# SYSTEM DESCRIPTION

Astral Silencio is a top-quality sound-insulating low noise drainage and sewerage piping system suitable for drainage of both commercial and residential wastewater. Astral Silencio can endure hot and cold wastewater and fulfills all the requirements of non-pressurized wastewater piping as laid down in DIN EN 12056 and DIN 1986-100.

Astral Silencio is manufactured with Mineral Reinforced Polypropylene which helps to reduce the noise level of soil and waste discharge systems better than alternative materials. Apart from superior acoustic properties, Astral Silencio also offers significantly enhanced mechanical properties and can be the one-stop solution for many challenging wastewater discharge applications.

Astral Silencio sound-insulating piping system is designed to ensure a comfortable environment. The pipe dimensions are in accordance with EN 1451 (Plastic piping systems for soil and waste discharge - low and high temperature - within the building structure for PP. Specifications for pipes, fittings and the system) or EN 1401 (Plastic piping systems for non-pressure underground drainage and sewerage for PVC-U. Specifications for pipes, fittings and the system) and this enables the trouble-free transition from other piping systems to Astral Silencio without the need of special transition adapters.

Astral Silencio is available in nominal diameter from 40 mm to 200 mm with a comprehensive range of fittings and accessories to accomplish the system. Its joining process is simple push fit technology with a special rubber ring and it is easily compatible with different kinds of piping systems like uPVC, PP or PE without the need of any special adapters.

Astral Silencio is one of the most advanced plastic drain and waste piping systems and it is established as a superior alternative to cast iron drain pipes with the following additional benefits:

- Fast and easy installation
- Enhanced acoustic properties
- Trouble-free lifelong performance
- Lower weight of the piping system

## THE RAW MATERIAL

Astral Silencio's polypropylene mineral-filled compound has been carefully designed to provide both excellent acoustic and mechanical properties. Astral Silencio has a molecular density of 1.9 gm/cm<sup>3</sup> which is one of the highest in the industry and it significantly improves the sound dampening properties of the wastewater drainage system. Our compound offers superior ring stiffness and impact resistance which are essential for a drainage and sewerage piping system. Apart from these unique properties, Astral Silencio is durable, corrosion-resistant and able to withstand the chemical aggression of various kinds of wastewater. The smooth inner surface of Astral Silencio prevents scaling and incrustation.



# FIELDS OF APPLICATION

The sound-insulating Astral Silencio is suitable for gravity drainage system as laid down in DIN EN 12056 (Gravity Drainage Systems Inside Buildings-Sanitary Pipework, Layout and Calculation) and DIN 1986-100 (Drainage System on Private Ground). Local - national standards, code of practice and regulations must be followed during the design and installation of drainage system using Astral Silencio. The pipes, fittings and seals can operate continuously at 90°C / 194°F (95°C/203°F Intermittently). They are suitable for the drainage of chemically aggressive wastewater with pH value of 2 (acidic) to 12 (basic). Fire resistance of Astral Silencio corresponds to B2 normal combustibility according to DIN 4102 (Fire behaviour of Building Materials & Building Components-Building materials, concepts, requirements and tests) and D-s2, d0 according to EN 13501-1. (Fire classification of construction products and building elements- classification using data from reaction to fire tests) The pipe connections are leak-proof up to an internal excess water pressure of 0.5 bar (5 m /16.4 feet) water column. The possible usage of Astral Silencio is shown in the following figure:

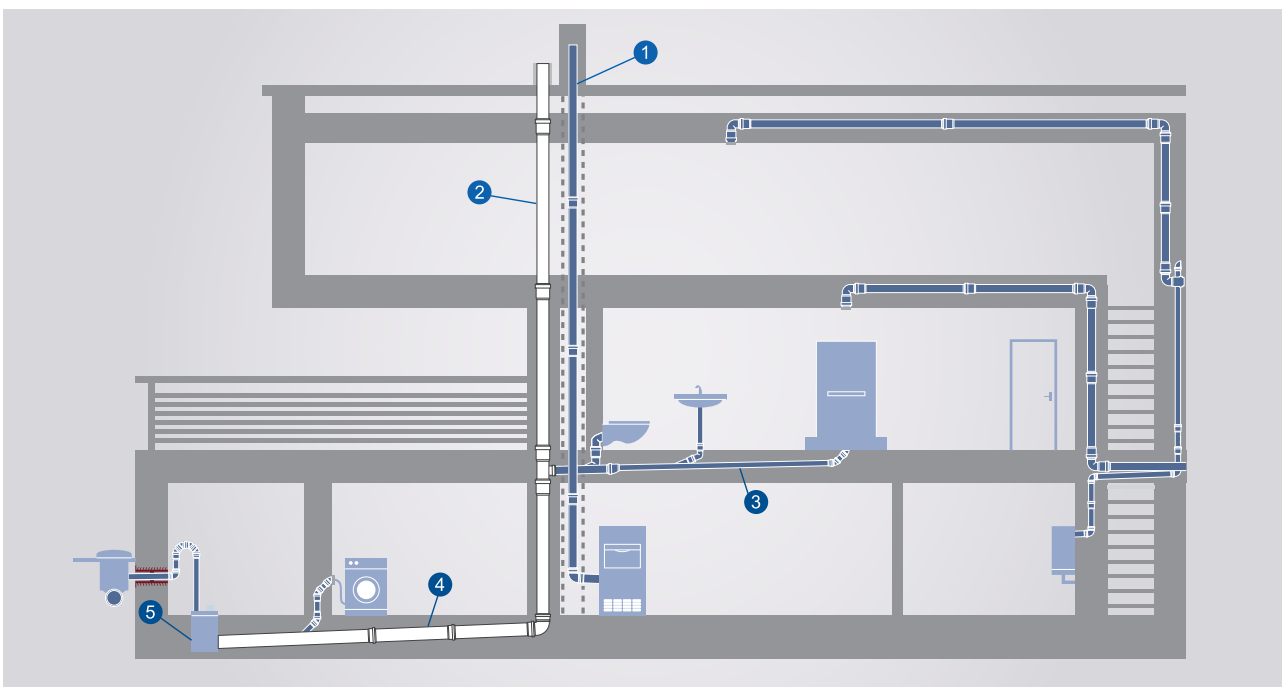

1. RAIN STACK PIPE, 2. SOIL PIPE, 3. WASTE DRAIN PIPE, 4. UNDERGROUND PIPE TO INSPECTION CHAMBER, 5. INSPECTION CHAMBER

## RESIDENTIAL BUILDINGS



Due to its excellent sound insulating properties (<10dB @2LPS as per EN 14366-Laboratory measurement of noise from wastewater installations), Astral Silencio is an ideal choice for all kinds of residential buildings where noise reduction is required as per DIN 4109 (Sound insulation in Buildings-Minimum requirements) / VDI 4100 (Sound insulation between rooms in buildings-Dwellings-Assessment and proposals for enhanced sound insulation between rooms). It can be used for standard drainage systems also. The typical examples of such occupancies are;

- Single Family House
- Condominiums
- Multi-storey Residential Apartments

Apart from the noise generated by external sources, internal sources are also responsible for noise generation. Astral Silencio reduces the drain noise considerably and enables the living spaces to be quiet and comfortable. The maximum detectable flow noise in this system is less than the noise generated by the ticking of a wristwatch.

## LARGE COMMERCIAL BUILDINGS



Astral Silencio also can be installed in buildings with elevated sound insulation requirements as per VDI guideline 4100 (Sound insulation between rooms in buildings-Dwellings-Assessment and proposals for enhanced sound insulation between rooms). Thanks to its excellent sound insulation properties, Astral Silencio is the ideal choice for Hotels, Office buildings, Hospitals, Restaurants, Rehabilitation Homes, Libraries, Community Centers and Educational Institutes.

## COMMERCIAL KITCHENS



Astral Silencio is ideal for application such as an inlying collecting pipe for draining greasy wastewater from commercial kitchens to the grease separator. Due to its high-temperature resistance (short-term exposure to 95°C / 203°F) long-term exposure to 90°C /194°F, Astral Silencio would be the ideal choice for commercial kitchens where wastewater with high temperature is drained. It has also accomplished the basic prerequisites of DIN EN 12056 (Gravity Drainage Systems Inside Buildings-Sanitary Pipework, Layout and Calculation) and the associated norms of DIN 1986-100 (Drainage System on Private Ground).

For grease separators at a great distance, the use of pipe trace heating may be necessary. This prevents premature grease accumulation. The ideal temperature of the pipe trace heating for plastic pipes may not exceed 70°C /158°F. Apart from this, Astral Silencio can be used for other applications like Industrial

Environment, Laboratory Drainage and Chemical Industries. Please contact us for such specific requirements for further guidance.

## CHEMICAL RESISTANCE



Astral Silencio is resistant to a wide variety of chemicals and can be used for drainage of such harsh chemicals. Please refer Chemical Resistance section of this catalogue to see the chemical resistance chart of Astral Silencio.

N. B. The data is used for the initial orientation of the chemical resistance of the material (not of the possible influence of the corrosive agent) and cannot simply be applied to all usage scenarios. Mechanical behavior can be impaired in cases where tension and the presence of chemicals occur simultaneously (tension-fracture corrosion).

If required, we recommend testing the suitability of the pipe, fitting and seal material in existing systems or have them checked in a laboratory. Contact us for such applications if necessary.



# PIPE STRUCTURE

An outstanding feature of Astral Silencio is the 3 layer construction and adaption of each individual layer to its respective requirements. Technically desirable characteristics are optimized in a targeted way. This is achieved with modern design principles of Sandwich construction.

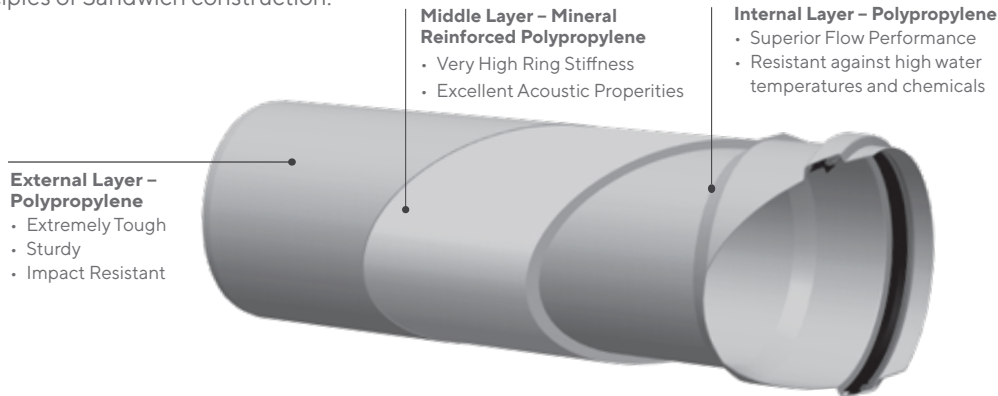

Three separate layers impart unique characteristics to the pipe. The abrasion-resistant low friction inner layer ensures the easy transit of waste. The mineral-filled mid-layer ensures enhanced sound dampening properties and also offers increased stiffness. Finally, the robust outer layer is tough enough to withstand impacts and shocks.

These ideal characteristics are achieved through the three-layer structure of the pipe and the specialized adaptation of each individual layer to its respective requirement:

- High ring stiffness
- Excellent impact strength of the outer layer at low temperature
- Increased UV-resistance
- Abrasion-resistant and smooth inner layer
- Highly rigid and sound-insulating middle layer made of mineral reinforced Polypropylene

# FITTINGS & FEATURES

The pipe system would experience local vibrations at redirections due to critical drainage conditions. This can have a negative effect on sound related properties. To minimize this effect and to counter the negative influences, it is very important to have proper design and mass of fittings. Astral Silencio fittings are specifically designed to address this.

The fittings too have the same density of  $1.9 \text{ gm/cm}^3$  as pipes and are made of identical PP mineral-filled compounds. A special fittings are designed like access pipes, Clean out Tees and Bends (Door Tee and Door Bend) with special inner cap that ensures smooth flow as well as minimum sound generation.

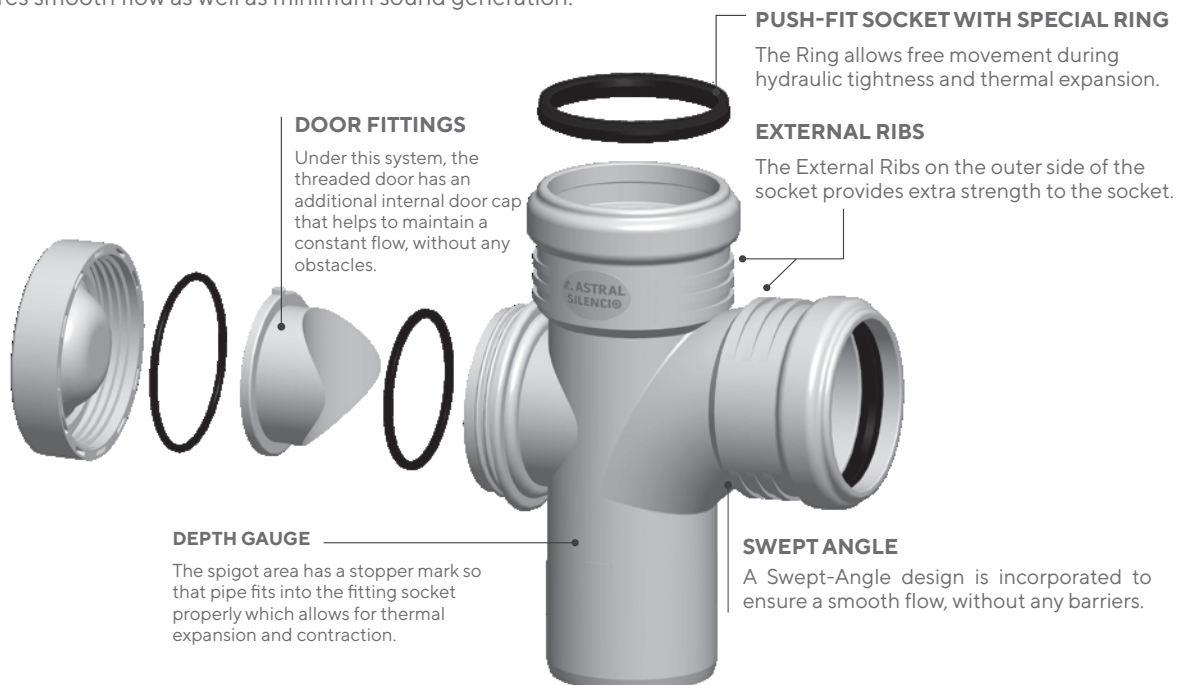

# KEY PROPERTIES



## NOISE INSULATION AT ITS BEST

The high molecular formula of middle layer enables the superior acoustic requirement and performance. Excellent soundproofing performance is measured in Fraunhofer laboratory which complies with EN 14366 (Laboratory measurement of noise from wastewater installations), equal to <math><10\text{dB}</math> with a flow rate of 2 lps.



## AS STRONG AS METAL

Astral Silencio with its high molecular weight, imparts excellent physical and mechanical properties to the pipe. It gives high ring stiffness to the pipes and hence, can be used as effective alternative to the cast iron drainage pipes.



## EASY INSTALLATION

Without use of any special tools, the push fit joining installation of Astral Silencio is simple, quick and efficient. No solvent cement is needed. Also, joints are leakproof.



## CHEMICAL RESISTANCE

Astral Silencio can handle the waste liquid with pH value 2 to 12. It has a high resistance to the most common chemical substances. The inner layer of the pipe is made of PP which has natural property to prevent the accumulation of deposits in the pipe.



## HIGH IMPACT RESISTANCE, EXTREMELY TOUGH

Both the external and internal layers of PP have excellent impact strength and abrasion-resistance with smooth inner surface. Astral Silencio products show high impact resistance at extremely harsh temperature as low as



## RESISTANCE TO HOT WATER

Astral Silencio is hot water resistant - short term



## SMOOTH INNER SURFACE

The smooth inner surface does not allow the waste liquid to stick to the surface, enabling superior flow and fewer chances of blockage.



## ECO FRIENDLY PRODUCT & PROCESS

Astral Silencio is designed with a strong eco-friendly focus, aiming to minimize its environmental impact throughout its life-cycle. From production to disposal, it uses less energy, water, and resources, while generating less waste.

# WHAT IS NOISE?

Noise can be described as any unwanted sound. In relation to sound, noise is not necessarily random. The table given below shows the decibel levels of sounds of common phenomenon observed in day-to-day life.

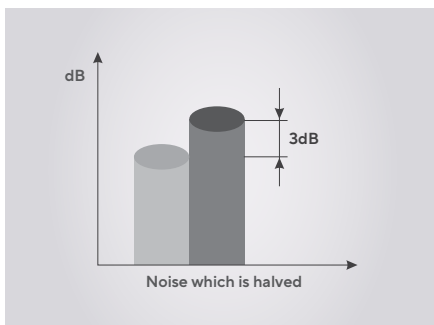
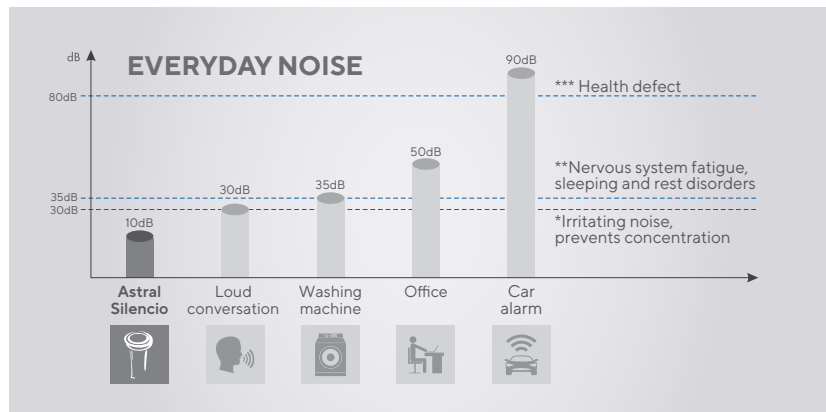

It is noted that the human ear is sensitive to pressure intensity in a non-linear way, therefore twice the pressure does not correspond to twice the sensation. In other words, a decrease of 3 dB sound level results in a reduction of half of the noise.

In every area of building construction, especially the construction of multi-storey apartment blocks, hospitals and rehabilitation homes, sound insulation plays an increasingly important role. One of the most significant sources of sound within buildings is the sanitation setup and the accompanying drainage water pipe system.

Typical sources of sound include:

Fitting noises • Filling noises • Draining noises • Inlet noises • Impact noises • Turbulence

Unsuitable drainage pipe system and types of brackets are major contributors to disturbing noises. Generally, two types of sounds are differentiated for wastewater systems:

## AIR BORNE NOISE

Airborne noise is present if the noises of a sound source are transferred directly through the air to human ears.

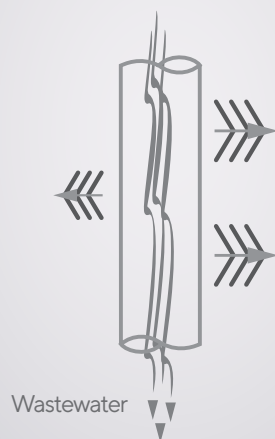

## STRUCTURE-BORNE NOISE

With structure borne noise, the sound transfers through a solid body. This body vibrates and passes the vibration to the human ears as airborne noise.

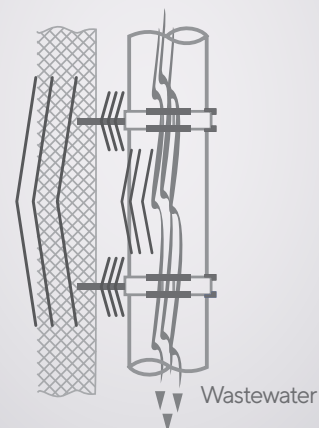

The impact and flow noises are responsible for airborne and structure-borne sounds which develop at the piping wall. The type and intensity of these pipe vibrations depend on a variety of factors, such as the mass of the pipe, the pipe material and its inner damping. The biggest problem with a building's plumbing drainage is with the transfer of structure-borne sound at the point of pipe fixing. When developing a sound-insulating drainage water system, both types of noise distribution must be taken into account.

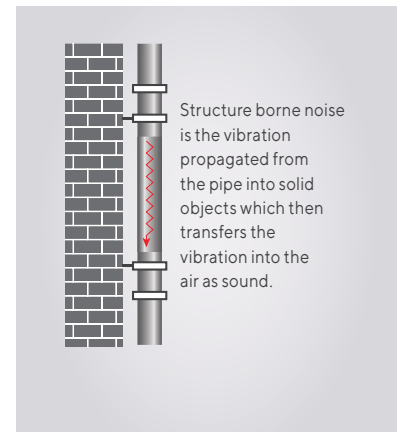
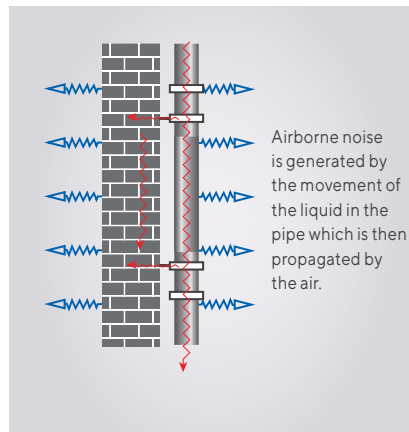
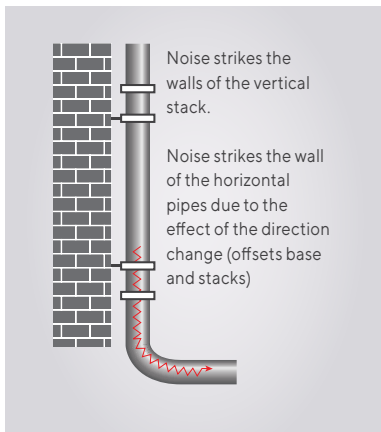

Key

Structure Borne Noise

Airborne Noise

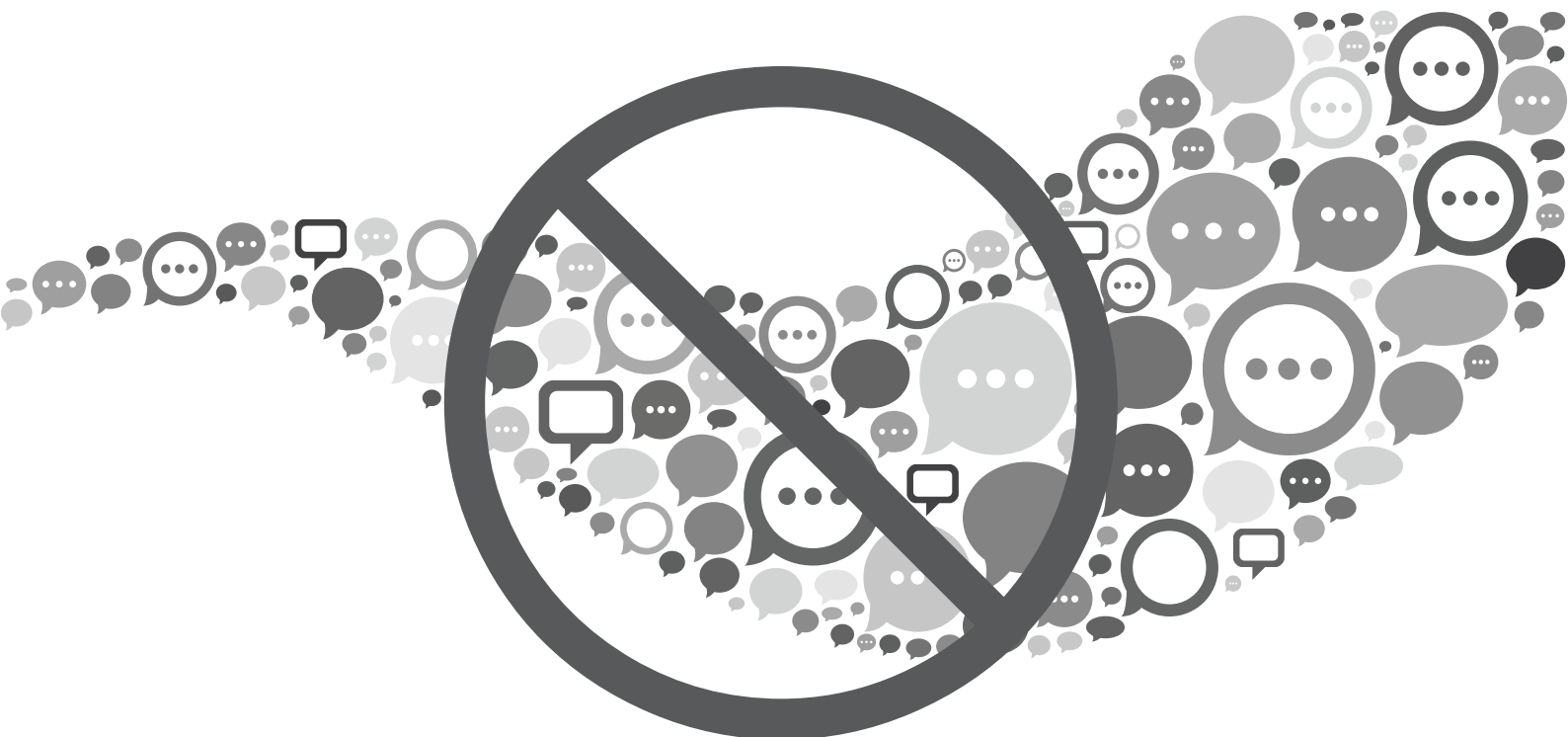

# SOUND-INSULATION REQUIREMENTS

There are currently two important bodies of rules for sound insulation in residential buildings DIN 4109 (Sound insulation in buildings -Requirements and verifications, issued November 1989) and VDI guideline 4100 (Sound insulation in residential buildings – Criteria for planning and assessment, issued September 1994)

## DIN 4109

Building drainage systems are to be planned under observance of DIN 4109. DIN 4109 defines the requirements for rooms in unknown living areas which must be insulated. These include:

- Bedrooms
- Living areas
- Classrooms
- Workspace (offices, treatment rooms, conference rooms, etc.)

If there are no requirements for your own living area, a maximum 30 dB(A) is stipulated for water installations (water supply and sewer pipe systems together). This standard contains requirements for sound insulation so that the people in living spaces can be protected from the stress caused by unwanted sound transmission. A sound-insulation level is required which must be maintained to protect against health risks caused by sound.

## VDI GUIDELINE 4100

VDI guideline 4100 (Sound insulation between rooms in buildings- Dwellings- Assessment and proposals for enhanced sound insulation between rooms) represents more stringent sound - insulation requirements. It defines three sound-insulation levels and differentiates among apartments, multi-storey apartment blocks, semi-detached houses and row houses. These guidelines, in contrast to DIN 4109 (Sound insulation in Buildings-Minimum requirements), also take living spaces into consideration that include water supply and sewer pipe systems together.

Sound Insulation Level	Apartments In Multi-storey Apartment Block	Apartments In Semi detached Houses and Row Houses	Your Own Living Area
I	30 dB (A) (purs. to DIN 4109)	30 dB (A) (purs. to DIN 4109)	30 dB (A)
II	30 dB (A)	25 dB (A)	30 dB (A)
III	25 dB (A)	20 dB (A)	30 dB (A)

## SOUND-INSULATION REQUIREMENTS

PURSUANT TO VDI GUIDELINE 4100







# SOUND INSULATION BY ASTRAL SILENCIO

The excellent sound insulation properties of Astral Silencio are primarily attributed to its thick-walled design as well as the special molecular structure and the high density of 1.9 g/cm<sup>3</sup>. This property enables Astral Silencio to absorb air-borne sound as well as mechanical vibrations.

The measurements in this test were performed following German standard DIN EN14366 (Laboratory measurement of noise from waste-water installations) and DIN 4109 (Sound insulation in Buildings-Minimum requirements); noise excitation by stationary water flow with 0.5 l/s, 1.0 l/s, 2.0 l/s., 3.0 l/s and 4.0 l/s.

In order to precisely determine real noise emission of the pipe system in a room, it requires a more dynamic test setup.

<b>Determination of the Acoustic Performance of a Wastewater Installation System in the Laboratory according to DIN EN 14366</b>		<b>P-BA 286/2021e</b>																																															
		<b>Results sheet 1</b>																																															
<b>Client:</b>	ASTRAL LIMITED, AHMEDABAD – 380 059, India																																																
<b>Test specimen:</b>	Wastewater system made of plastic, type: "ASTRAL SILENCIO" (manufacturer: Astral Limited); consisting of straight pipes and fittings (OD 110) as well as acoustic pipe clamps with elastic inlay, type: "BISMAT® 1000" (manufacturer: Walraven GmbH); test object S 11862-01; see figure 4 and 5.																																																
<b>Test set-up:</b>	<ul style="list-style-type: none"> <li>- The pipe system was mounted according to figure 4 and 5 (see also Annex A).</li> <li>- The pipe system consisted of straight wastewater pipes (nominal size OD 110), three inlet tees (~88°, rounded), a 2 x 45° basement bend and a horizontal drain section. Lids supplied by the manufacturer closed the inlet tees in the basement and in the ground floor.</li> <li>- <b>Pipe system:</b> type: "ASTRAL SILENCIO, High Density Low Noise System; DN 110x5.3 mm"; three-layer pipes with shaped pipe sockets, material: PP/PP-MD/PP, wall thickness: 5.8 mm, weight: 3.39 kg/m, density: 1.79 g/cm<sup>3</sup>. One-layer fittings, material: PP-MD, wall thickness: 5.5 mm, density: 1.97 g/cm<sup>3</sup>, above-mentioned values measured by IBP; manufacturer information: density (pipe + fitting): 1.9 g/cm<sup>3</sup>, pipe wall thickness: min. 5.3 mm. Plug connection of the pipes and fittings (shaped pipe sockets).</li> <li>- <b>Pipe clamps:</b> Acoustic pipe clamps, type: "BISMAT® 1000" (manufacturer: Walraven GmbH); structure-borne sound insulating support attachment consisting of BISMAT® SL loose clamps and BISMAT® SX socket clamps fixed to the installation wall with an adjustable wall plate with dowels and thread rods. In every storey (EG and UG) respectively two clamps were installed. At the upper wall area one loose clamp (SL, DN 100) was mounted. At the lower wall area one double clamp consisting of supporting clamp (SL, DN 100) and fixing clamp (SX, DN 100) was installed (figure 5). To prevent contact to the pipe, the loose clamp (SL) was mounted with 15 mm space between the locking tabs of the clamp (two 7.5 mm spacers on each side). The clamps were closed with a tightening torque of 2 Nm. The wastewater installation system was mounted by a technician under the authority of Fraunhofer IBP.</li> </ul>																																																
<b>Test facility:</b>	Installation test facility P12, mass per unit area of the installation wall: 220 kg/m <sup>2</sup> , mass per unit area of the ceiling: 440 kg/m <sup>2</sup> . Installation rooms: sub-basement (KG), basement (UG) front, ground floor (EG) front and top floor (DG), measuring rooms: UG front, UG rear (details in Annex P and DIN EN 14366:2020-02).																																																
<b>Test method:</b>	The measurements were performed according to DIN EN 14366:2020-02; noise excitation by steady water flow with 0.5 l/s, 1.0 l/s, 2.0 l/s and 4.0 l/s. Additional evaluation for comparison with requirements following German standards DIN 4109:2018-01 and VDI 4100:2012-10 (details in Annexes A, F and V).																																																
<b>Result:</b>	<table border="1"> <thead> <tr> <th rowspan="2">Test specimen: Wastewater system made of plastic, type: "ASTRAL SILENCIO" (manufacturer: Astral Limited); consisting of straight pipes and fittings (OD 110) as well as acoustic pipe clamps with elastic inlay, type: "BISMAT® 1000" (manufacturer: Walraven GmbH).</th> <th rowspan="2"></th> <th colspan="4">Flow rate [l/s]</th> </tr> <tr> <th>0.5</th> <th>1.0</th> <th>2.0</th> <th>4.0</th> </tr> </thead> <tbody> <tr> <td>Airborne sound pressure level <math>L_{p,A}</math> [dB(A)] according to DIN EN 14366 for the basement test-room</td> <td>UG front</td> <td>41</td> <td>44</td> <td>48</td> <td>50</td> </tr> <tr> <td>Structure-borne sound characteristic level <math>L_{s,A}</math> [dB(A)] according to DIN EN 14366 for the basement test-room</td> <td>UG rear</td> <td>&lt;10</td> <td>&lt;10</td> <td>&lt;10</td> <td>13</td> </tr> <tr> <td rowspan="2">Installation sound level <math>L_{\text{FREQ}}</math> [dB(A)] following DIN 4109 in the basement test-room</td> <td>UG front</td> <td>41</td> <td>44</td> <td>48</td> <td>50</td> </tr> <tr> <td>UG rear</td> <td>&lt;10</td> <td>&lt;10</td> <td>10</td> <td>16</td> </tr> <tr> <td rowspan="2">Installation sound level <math>L_{\text{AFREQ,IT}}</math> [dB(A)] following VDI 4100 in the basement test-room</td> <td>UG front</td> <td>38</td> <td>41</td> <td>46</td> <td>48</td> </tr> <tr> <td>UG rear</td> <td>&lt;10</td> <td>&lt;10</td> <td>&lt;10</td> <td>13</td> </tr> </tbody> </table>					Test specimen: Wastewater system made of plastic, type: "ASTRAL SILENCIO" (manufacturer: Astral Limited); consisting of straight pipes and fittings (OD 110) as well as acoustic pipe clamps with elastic inlay, type: "BISMAT® 1000" (manufacturer: Walraven GmbH).		Flow rate [l/s]				0.5	1.0	2.0	4.0	Airborne sound pressure level $L_{p,A}$ [dB(A)] according to DIN EN 14366 for the basement test-room	UG front	41	44	48	50	Structure-borne sound characteristic level $L_{s,A}$ [dB(A)] according to DIN EN 14366 for the basement test-room	UG rear	<10	<10	<10	13	Installation sound level $L_{\text{FREQ}}$ [dB(A)] following DIN 4109 in the basement test-room	UG front	41	44	48	50	UG rear	<10	<10	10	16	Installation sound level $L_{\text{AFREQ,IT}}$ [dB(A)] following VDI 4100 in the basement test-room	UG front	38	41	46	48	UG rear	<10	<10	<10	13
Test specimen: Wastewater system made of plastic, type: "ASTRAL SILENCIO" (manufacturer: Astral Limited); consisting of straight pipes and fittings (OD 110) as well as acoustic pipe clamps with elastic inlay, type: "BISMAT® 1000" (manufacturer: Walraven GmbH).		Flow rate [l/s]																																															
		0.5	1.0	2.0	4.0																																												
Airborne sound pressure level $L_{p,A}$ [dB(A)] according to DIN EN 14366 for the basement test-room	UG front	41	44	48	50																																												
Structure-borne sound characteristic level $L_{s,A}$ [dB(A)] according to DIN EN 14366 for the basement test-room	UG rear	<10	<10	<10	13																																												
Installation sound level $L_{\text{FREQ}}$ [dB(A)] following DIN 4109 in the basement test-room	UG front	41	44	48	50																																												
	UG rear	<10	<10	10	16																																												
Installation sound level $L_{\text{AFREQ,IT}}$ [dB(A)] following VDI 4100 in the basement test-room	UG front	38	41	46	48																																												
	UG rear	<10	<10	<10	13																																												
<b>Test date:</b>	December 7, 2021																																																
<b>Notes:</b>	<ul style="list-style-type: none"> <li>- For comparing test results with requirements according to DIN 4109 and VDI 4100 note Annex A.</li> <li>- The above-mentioned measurement results require careful assembly of the pipe clamps (see test set-up).</li> <li>- Sound levels below 10 dB(A) are not mentioned in the official test report, since they are subject to an increased measurement uncertainty and moreover are not noticeable in a normal living environment.</li> </ul>																																																
	The test was carried out in a laboratory, accredited according to DIN EN ISO/IEC 17025:2018 by DAkkS. The accreditation certificate is D-PL-11140-11-01. Stuttgart, February 23, 2022 Head of Laboratory: 																																																

**Representation of the test object, measurement setup**

**P-BA 286/2021e**

**Client:** ASTRAL LIMITED, AHMEDABAD – 380 059, India

**figure 4**

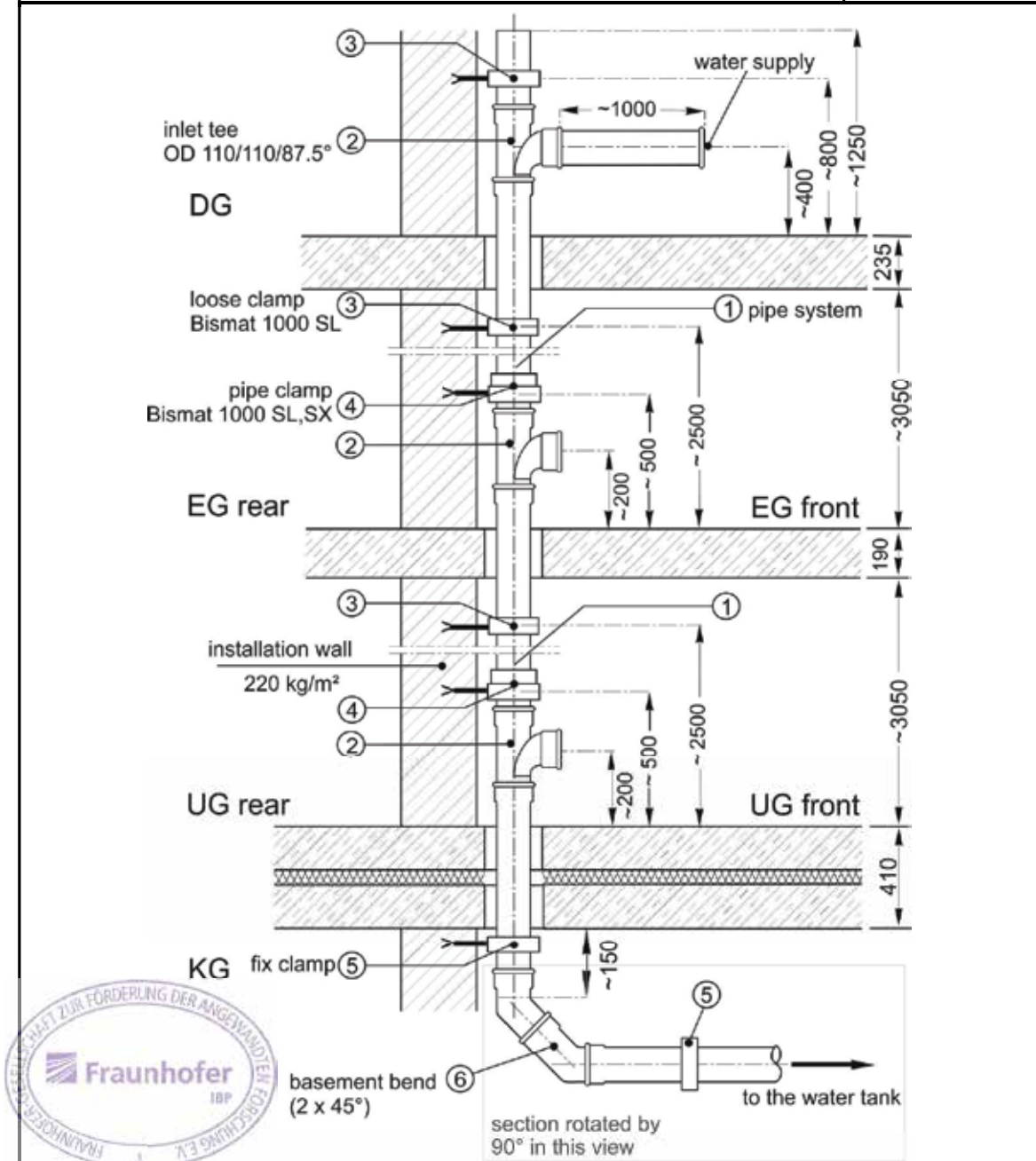

Installation plan of the test set-up in the test facility. Illustration simplified, schematically drawn and not to scale.

**Test specimen:** Wastewater system made of plastic, type: "ASTRAL SILENCIO" (manufacturer: Astral Limited); consisting of straight pipes and fittings (OD 110) as well as acoustic pipe clamps with elastic inlay, type: "BISMAT® 1000" (manufacturer: Walraven GmbH). In every storey (EG and UG) respectively two clamps were installed. At the upper wall area one loose clamp (SL, DN 100) was mounted. At the lower wall area one double clamp consisting of supporting clamp (SL, DN 100) and fixing clamp (SX, DN 100) was installed (figure 5). To prevent contact to the pipe, the loose clamp (SL) was mounted with 15 mm space between the locking tabs of the clamp (two 7.5 mm spacers on each side). Further information on the test setup can be found in the results sheet 1 as well as figure 5.



The test was carried out in a laboratory, accredited according to DIN EN ISO/IEC 17025:2018 by DAkkS. The accreditation certificate is D-PL-11140-11-01.

# ACOUSTIC PLUMBING DESIGN

Astral Silencio is high-performance sound-insulating waste-water piping system, however it is still necessary to consider how effectively the system can be sound-isolated. This applies to the wastewater discharge system as a whole, including its points of contact with the building structure (pipe brackets and clamps, the running of pipework through walls and ceilings, mortar droppings between pipes and wall surfaces, etc.)

When planning pipe installation, waste-water discharge pipes should not be allowed to run inside the walls separating living areas. The attachment of waste-water discharge pipes to the partition walls in living areas should only be carried out under application of special noise protection measures. DIN 4109 (Sound insulation in Buildings-Minimum requirements) requires that single-skin walls to which, or in which, water installations or equipment (i.e. waste-water pipes) are to be attached must have an area-related mass of at least  $220 \text{ kg/m}^2$ . Walls having an area-related mass of less than  $220 \text{ kg/m}^2$  may only be used where prior testing has demonstrated that the walls exhibit acceptable properties with respect to the transmission of noise.

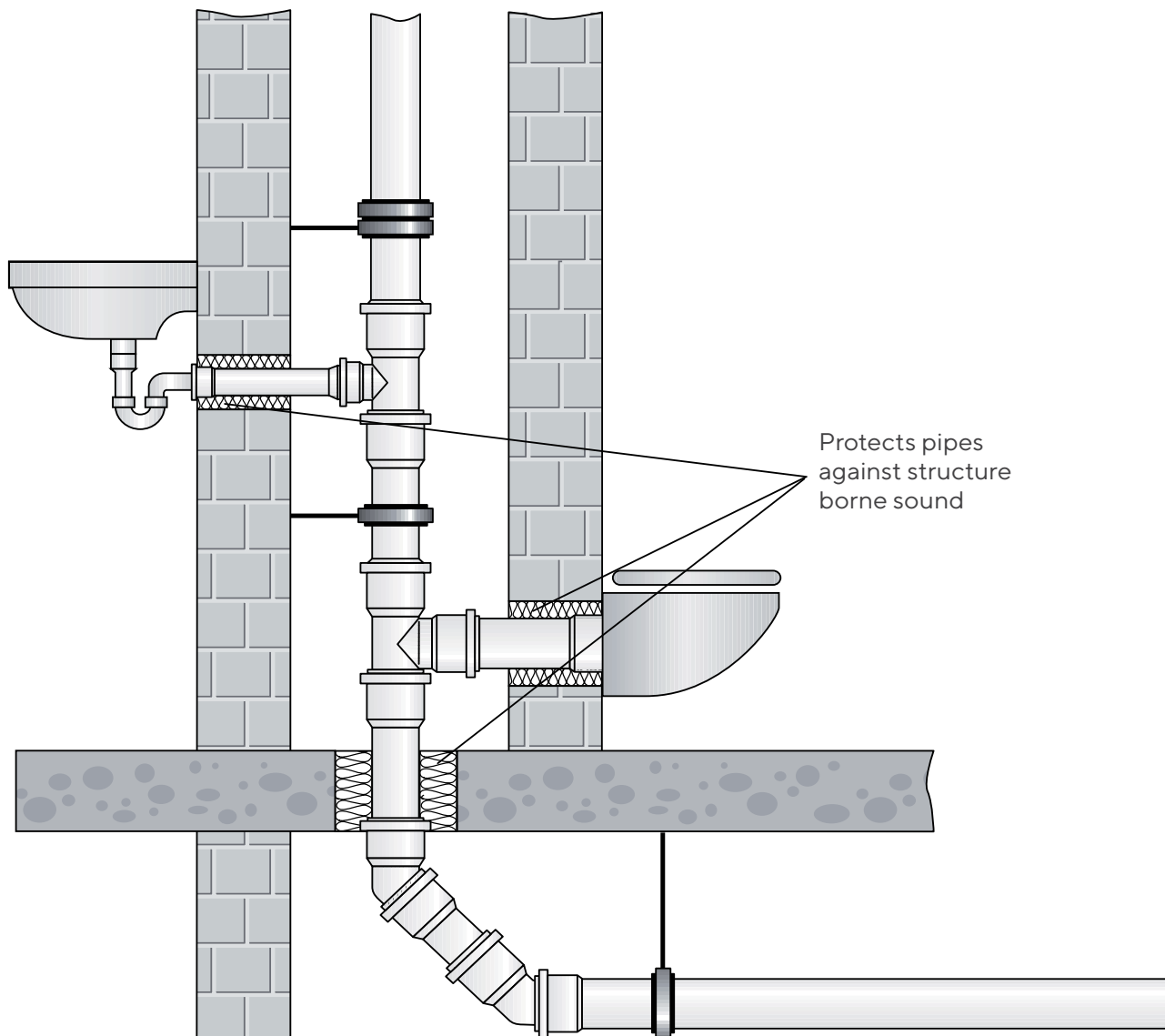

# FIRE BEHAVIOUR CLASSIFICATION

Fire behaviour of construction materials, e.g. piping systems and isolation materials, has been defined in fire classification classes as per DIN 4102-1 (Fire behaviour of Building Materials & Building Components-Building materials, concepts, requirements and tests). Construction materials are classified as combustible and non-combustible materials. Astral Silencio is listed as B2 non-readily ignitable as per DIN 4102-1 (Fire behaviour of Building Materials & Building Components-Building materials, concepts, requirements and tests).

Criteria	Old Classification as per DIN 4102-1	New European classification according to DIN EN 13501-1		
		Additional criteria		
Non-combustible	A1	A1		
	A2	A2	s1	d0
Non-readily ignitable (low flame spread)	B1	B	s1	d0
		C	s1	d0
		A2	s2/s3	d0
		B	s2/s3	d0
		C	s2/s3	d0
		A2	s1	d1/d2
		B	s1	d1/d2
		C	s1	d1/d2
		A2	s3	d2
Normally ignitable (normal fire behaviour)	B2	D	s1/s2/s3	d0
		E	-	d0
		D	s1/s2/s3	d2
		E	-	d2
Readily ignitable	B3	F	-	-

Fire behaviour classification according to DIN 4102-1 (Fire behaviour of Building Materials & Building Components - Building materials, concepts, requirements and tests) and DIN EN 13501-1 (Fire classification of construction products and building elements-Classification using data from reaction to fire tests).

In line with European standardization, the fire classification classes as per DIN 4102-1 (Fire behaviour of Building Materials & Building Components-Building materials, concepts, requirements and tests) are translated into the European DIN EN 13501 (Fire classification of construction products and building elements-Classification using data from reaction to fire tests). The accreditation is based on the standardized Single-Burning-Item-Test (SBI) in conformity with DIN EN 13823 (Reaction to fire tests for building products-building products excluding flooring exposed to the thermal attack by a single burning item).

# FIRE RESISTANCE CLASSIFICATION

The fire resistance classification provides the fire resistance duration of a specific construction material.

Fire resistance classification	Fire resistance duration in minutes
F30	≥ 30 = fire retardant
F60	≥ 60 = high fire retardant
F90	≥ 90 = fire resistant
F120	≥ 120 = high fire resistant
F180	≥ 180 = extreme fire resistant

## FIRE RESISTANCE CLASSIFICATION

Possible additions to these fire resistance classes, e.g. z.B. F90 A or F90 AB, can be explained as follows:

- A made of non-combustible materials
- B made of combustible materials
- AB in principle made of non-combustible materials

## FUNCTION OF FIRE PROTECTION COLLAR

When exposed to fire and heat, the plastic pipe becomes malleable and deforms. The Astral Fire Protection Collar fully seals the wall or ceiling corridor and helps in case of fire. Due to special fire protection material, which strongly expands by increase in temperature, the fire collar provides fire-resistant sealing for wall and ceiling installation of Astral Silencio acoustic insulation systems and to other selected soil and waste systems.

## GENERAL RECOMMENDATIONS

(1) Positioning of the collars:

On both sides of a wall; on one side under/in a ceiling.

(2) Wall & ceiling types:

At least 10 cm / 4 inches thick solid concrete, aerated concrete and sand-lime brick walls as well as light dividing walls (stud walls: both sides clad with 12.5 mm / 0.5 inches plasterboard) and solid concrete and aerated concrete ceilings at least 15 cm / 6 inches thick.

(3) Structural acoustic insulation:

The acoustic insulation mat provided must be wrapped around the pipe where it passes through the wall or ceiling.

(4) Joint sealing between pipe and wall/ceiling:

To be packed to the full thickness of the wall or ceiling using mineral materials such as concrete, cement or plaster.



# TYPES OF INSTALLATION

## CEILING INSTALLATION

Minimum requirements of the ceiling: min. 15.0 cm / 6 inches thick concrete ceiling.

### FLUSH/STRAIGHT CEILING INSTALLATION

- Wrap insulating mat around the pipe
- Open the collar and position it around the pipe, whilst hooking in the push-in fastening
- Bend or angle the collar mounting tabs
- Install the collar flush with the ceiling
- Fill the remaining ceiling gap with cement or concrete
- Hold the collar firmly against the ceiling and mark the positions of the mounting holes
- Rotate the collar and drill the holes
- Insert plugs and fix the collar using screws and washers. (Mounting the collar using the washers, plugs and screws provided)

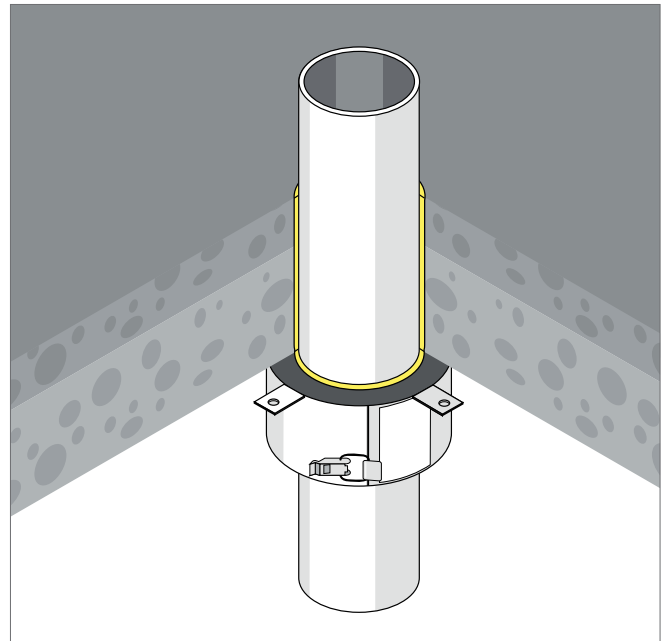

**INSTALLATION OF FIREPROOFING COLLAR ON CEILING**

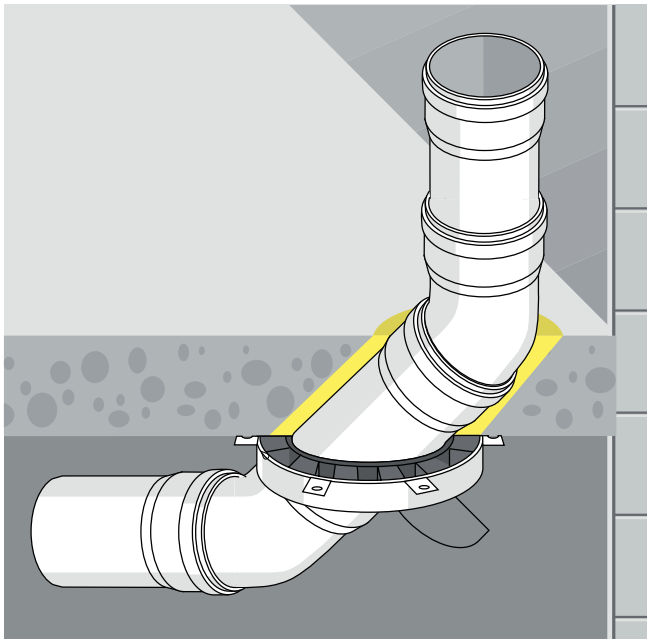

**INSTALLATION OF FIREPROOFING COLLAR IN ANGLED CEILING**

### ANGLED CEILING INSTALLATION

- Wrap insulating mat around the pipe
- Open the collar and position it around the pipe, whilst hooking in the push-in fastening
- Fill the remaining gap with cement or concrete
- Hold the collar firmly against the ceiling and mark the positions of the mounting holes
- Rotate the collar and drill the holes
- Insert plugs and fix the collar using screws and washers. (Mounting the collar using the washers, plugs and screws provided)

## **INSTALLATION DISTANCES BETWEEN FIRE PROTECTION COLLARS E.G. TO EXTERNAL SYSTEMS**

The distance to external, tested systems (inspected and approved) must be at least 50 mm / 2 inches between partitioned sections. If two Astral feedthroughs are installed next to each other, the distance between the pipes must be at least 100 mm / 4 inches in the case of special partitioned sections (sloping pipes, partition via sleeve/socket or for ceiling installations). In the case of straight pipes without sleeve/ socket in the partition area, the collar casings can adjoin each other (distance 0 mm).

## **WALL INSTALLATION**

Minimum wall specifications: wall must be at least 100 mm / 4 inches thick, made from concrete, aerated concrete, lime sandstone or lightweight partition walls (two-layer panelling on both sides with 12.5 mm / 0.5 inches plasterboard panels and mineral wool infill). The pipe must be clamped on both sides at a distance of  $\leq 50$  cm / 2 inches. For wall feedthroughs, a collar should always be fitted on both sides of the wall.

## **NOTE**

The presented data, especially recommendations for the processing and use of our products are based on our knowledge and experience. Due to differences in material and working conditions that are outside the scope of our influence, we recommend that sufficient internal trials should be conducted in each case to ensure the suitability of our product to the intended method and processing purposes. No liability will be accepted either on the basis of these instructions or from an oral advice, unless we are accused of gross negligence or deliberate malice.

Overview of possible installation situations:



# TECHNICAL SPECIFICATION

## TECHNICAL DATA

PROPERTY	UNIT	VALUE
Material	Pipe : PP/PP mineral filled/PP	
	Fitting : PP mineral filled	
	Rubber Seal: SBR	
Colour	Light grey, RAL 7035	
Area of application	Drainage pipes in building and above ground installation	
Density	g/cm <sup>3</sup>	1.9
Elongation@break	%	50
Tensile strength	MPa	20
Modulus of elasticity Single (1) Layer Triple (3) Layer	MPa	3800N 1500N
Coefficient of linear expansion	Mm/mk	0.09
Ring stiffness	KN/M <sup>2</sup>	21
Fire resistance	-	EN 13501-1:D-s2, d0 DIN 4102:B2 Normally ignitable (normal fire behaviour)
MFR	gm/10 min	2.1
Connections	Push Fit sockets with factory-inserted lip seals special rubber ring	
Application Environment	Wastewater with pH 2-12	
Operating Temperature	Water Temp. upto 95°C/203°F (Intermittent) or 90°C/194°F (continuous)	
Pipe marking	Astral Silencio, nominal diameter, production year, quality mark, approval, material, control mark, fire classification.	
Life Expectancy	50 years	

**PIPE DIMENSION**

Nominal Outside Diameter Size mm (inches)	Mean Outside Diameter (mm)		Wall Thickness (min.) (mm)
	Min.	Max.	
40 (1¼)	40.0	40.3	2.2
50 (1½)	50.0	50.3	4.0
63 (2)	63.0	63.3	4.0
75 (2½)	75.0	75.3	4.5
110 (4)	110.0	110.4	5.3
125 (5)	125.0	125.4	5.3
160 (6)	160.0	160.5	5.3
200 (8)	200.0	200.6	6.2

**SOCKET DIMENSION**

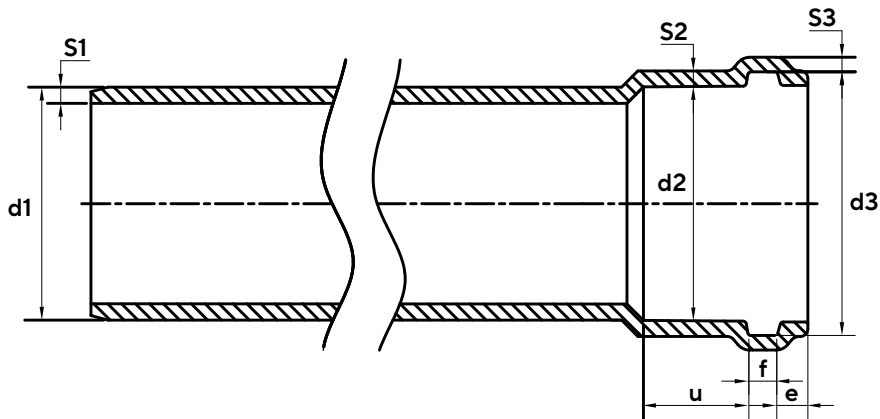

Nominal Outside Diameter Size mm (inches)	Wall Thickness of Pipe S1 min. (mm)	Wall Thickness of Socket S2 min. (mm)	Wall Thickness of Ring Groove S3 min. (mm)	Outside Diameter of Soc. d1 with tolerance (mm)	Inside Diameter of Soc. d2 min. (mm)	Inside Diameter at Ring Groove d3 with tolerance (mm)	Length of Soc. Neck e min. (mm)	Length of Ring Groove f max. (mm)	Length Beyond Ring Groove u min. (mm)
40 (1¼)	2.2	2.0	1.6	40.0 + 0.3	40.3	50.0 ± 0.8	5	12.0	26
50 (1½)	4.0	3.6	2.9	50.0 + 0.3	50.3	60.0 ± 1.0	5	12.0	28
63 (2)	4.0	3.6	2.9	63.0 + 0.3	63.3	73.0 ± 1.0	5	12.0	31
75 (2½)	4.5	4.1	3.2	75.0 + 0.3	75.3	85.0 ± 1.0	5	12.0	33
110 (4)	5.3	4.8	3.8	110.0 + 0.4	110.4	121.5 ± 1.0	6	14.0	34
125 (5)	5.3	4.8	3.8	125.0 + 0.4	125.4	138.0 ± 1.0	7	15.0	38
160 (6)	5.3	4.8	3.8	160.0 + 0.5	160.5	175.0 ± 1.2	9	15.0	41
200 (8)	6.2	5.6	4.5	200.0 + 0.6	200.6	217.0 ± 1.5	11.5	17.0	45

# PRODUCT



# RANGE



# SILENCIO PRODUCT RANGE

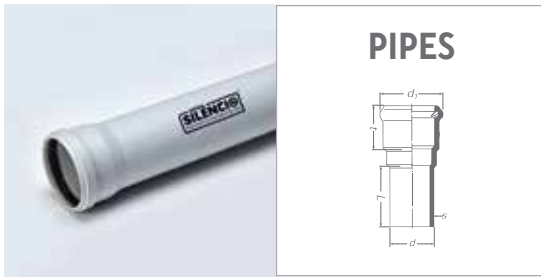

Size (cm)	Length & Type	Product Code	d (mm) (min.)	d1 (mm) (min.)	s (mm) (min.)	t (mm)	Std. Pkg. (Nos.)
4.0	3 M S/S	M241270304	40	53.0	2.2	43.0	52
4.0	3 M D/S	M241280304	40	53.0	2.2	43.0	52
4.0	1 RFT S/S	M241271104	40	53.0	2.2	43.0	01
4.0	2 RFT D/S	M241282204	40	53.0	2.2	43.0	01
4.0	3 RFT D/S	M241283304	40	53.0	2.2	43.0	01
4.0	4 RFT D/S	M241284404	40	53.0	2.2	43.0	01
4.0	6 RFT S/S	M241276604	40	53.0	2.2	43.0	01
4.0	6 RFT D/S	M241286604	40	53.0	2.2	43.0	01
5.0	3 M S/S	M241270305	50	65.2	4.0	45.0	52
5.0	3 M D/S	M241280305	50	65.2	4.0	45.0	52
5.0	1 RFT S/S	M241271105	50	65.2	4.0	45.0	01
5.0	2 RFT D/S	M241282205	50	65.2	4.0	45.0	01
5.0	3 RFT D/S	M241283305	50	65.2	4.0	45.0	01
5.0	4 RFT D/S	M241284405	50	65.2	4.0	45.0	01
5.0	6 RFT S/S	M241276605	50	65.2	4.0	45.0	01
5.0	6 RFT D/S	M241286605	50	65.2	4.0	45.0	01
6.3	3 M S/S	M241270306	63	78.2	4.0	48.0	30
6.3	3 M D/S	M241280306	63	78.2	4.0	48.0	30
6.3	1 RFT S/S	M241271106	63	78.2	4.0	48.0	01
6.3	2 RFT D/S	M241282206	63	78.2	4.0	48.0	01
6.3	3 RFT D/S	M241283306	63	78.2	4.0	48.0	01
6.3	4 RFT D/S	M241284406	63	78.2	4.0	48.0	01
6.3	6 RFT S/S	M241276606	63	78.2	4.0	48.0	01
6.3	6 RFT D/S	M241286606	63	78.2	4.0	48.0	01
7.5	3 M S/S	M241270307	75	91.0	4.5	50.0	36
7.5	3 M D/S	M241280307	75	91.0	4.5	50.0	36
7.5	1 RFT S/S	M241271107	75	91.0	4.5	50.0	01
7.5	2 RFT D/S	M241282207	75	91.0	4.5	50.0	01
7.5	3 RFT D/S	M241283307	75	91.0	4.5	50.0	01
7.5	4 RFT D/S	M241284407	75	91.0	4.5	50.0	01
7.5	6 RFT S/S	M241276607	75	91.0	4.5	50.0	01
7.5	6 RFT D/S	M241286607	75	91.0	4.5	50.0	01

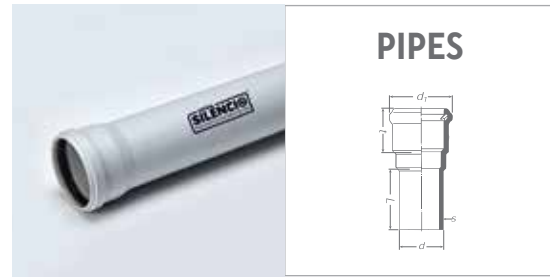

Size (cm)	Length & Type	Product Code	d (mm) (min.)	d1 (mm) (min.)	s (mm) (min.)	t (mm)	Std. Pkg. (Nos.)
11.0	3 M S/S	M241270309	110	128.5	5.3	54.0	18
11.0	3 M D/S	M241280309	110	128.5	5.3	54.0	18
11.0	1 RFT S/S	M241271109	110	128.5	5.3	54.0	01
11.0	2 RFT D/S	M241282209	110	128.5	5.3	54.0	01
11.0	3 RFT D/S	M241283309	110	128.5	5.3	54.0	01
11.0	4 RFT D/S	M241284409	110	128.5	5.3	54.0	01
11.0	6 RFT S/S	M241276609	110	128.5	5.3	54.0	01
11.0	6 RFT D/S	M241286609	110	128.5	5.3	54.0	01
12.5	3 M S/S	M241270310	125	145.0	5.3	60.0	15
12.5	3 M D/S	M241280310	125	145.0	5.3	60.0	15
12.5	1 RFT S/S	M241271110	125	145.0	5.3	60.0	01
12.5	2 RFT D/S	M241282210	125	145.0	5.3	60.0	01
12.5	3 RFT D/S	M241283310	125	145.0	5.3	60.0	01
12.5	4 RFT D/S	M241284410	125	145.0	5.3	60.0	01
12.5	6 RFT S/S	M241276610	125	145.0	5.3	60.0	01
12.5	6 RFT D/S	M241286610	125	145.0	5.3	60.0	01
16.0	3 M S/S	M241270312	160	182.0	5.3	65.0	12
16.0	3 M D/S	M241280312	160	182.0	5.3	65.0	12
16.0	1 RFT S/S	M241271112	160	182.0	5.3	65.0	01
16.0	2 RFT D/S	M241282212	160	182.0	5.3	65.0	01
16.0	3 RFT D/S	M241283312	160	182.0	5.3	65.0	01
16.0	4 RFT D/S	M241284412	160	182.0	5.3	65.0	01
16.0	6 RFT S/S	M241276612	160	182.0	5.3	65.0	01
16.0	6 RFT D/S	M241286612	160	182.0	5.3	65.0	01
20.0	3 M S/S	M241270314	200	227.0	6.2	73.5	06
20.0	3 M D/S	M241280314	200	227.0	6.2	73.5	06
20.0	1 RFT S/S	M241271114	200	227.0	6.2	73.5	01
20.0	2 RFT D/S	M241282214	200	227.0	6.2	73.5	01
20.0	3 RFT D/S	M241283314	200	227.0	6.2	73.5	01
20.0	4 RFT D/S	M241284414	200	227.0	6.2	73.5	01
20.0	6 RFT S/S	M241276614	200	227.0	6.2	73.5	01
20.0	6 RFT D/S	M241286614	200	227.0	6.2	73.5	01

\* Trading Item, # Shortly Introducing

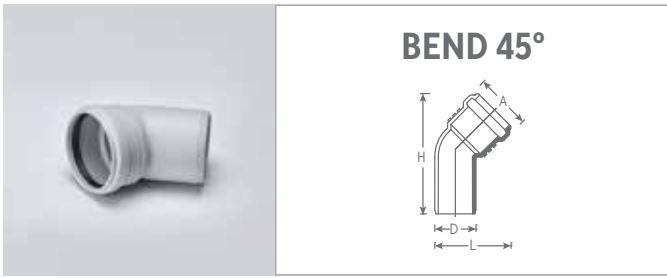

Size (cm)	Product Code	A (mm)	H (mm)	L (mm)	D (mm)	W.T. (mm)	Std. Pkg. (Nos.)
4.0	M242001104	54	135	84	40	2.0	120
5.0	M242001105	68	146	91	50	4.2	56
6.3	M242001106	81	159	107	63	4.2	70
7.5	M242001107	94	173	119	75	5.2	42
11.0	M242001109	130	209	158	110	5.5	20
12.5	M242001110	147	229	177	125	5.5	10
16.0	M242001112	184	263	214	160	5.6	10
20.0	M242001114	227	307	262	200	6.2	04

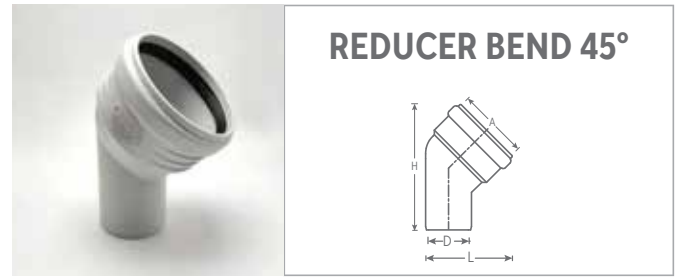

Size (cm)	Product Code	A (mm)	H (mm)	L (mm)	D (mm)	W.T. (mm)	Std. Pkg. (Nos.)
11.0 x 7.5	M242001129	130	205	145	75	5.5	35

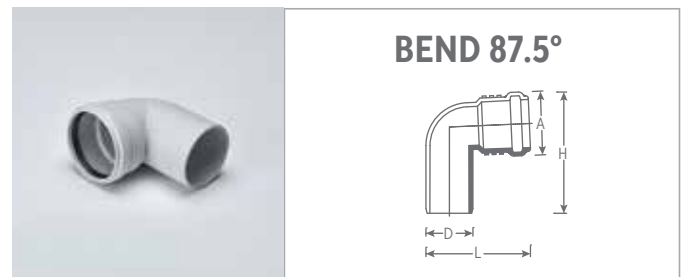

Size (cm)	Product Code	A (mm)	H (mm)	L (mm)	D (mm)	W.T. (mm)	Std. Pkg. (Nos.)
4.0	M242001204	54	102	98	40	2.0	100
5.0	M242001205	68	129	111	50	4.2	72
6.3	M242001206	81	114	123	63	4.2	60
7.5	M242001207	94	161	136	75	5.2	36
11.0	M242001209	130	205	176	110	5.5	12
12.5	M242001210	147	226	195	125	5.5	10
16.0	M242001212	184	273	230	160	5.6	09
20.0	M242001214	227	323	283	200	6.2	03

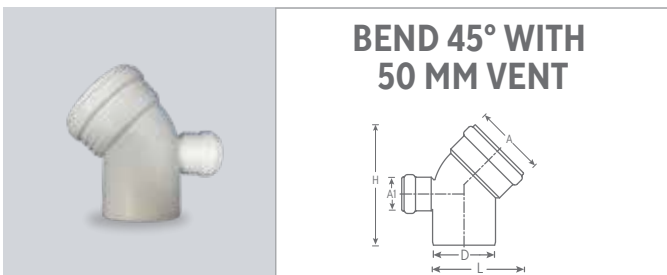

Size (cm)	Product Code	A x A1 (mm)	H (mm)	L (mm)	D (mm)	W.T. (mm)	Std. Pkg. (Nos.)
11.0	M2420014209	130x68	209	220	110	5.5	20

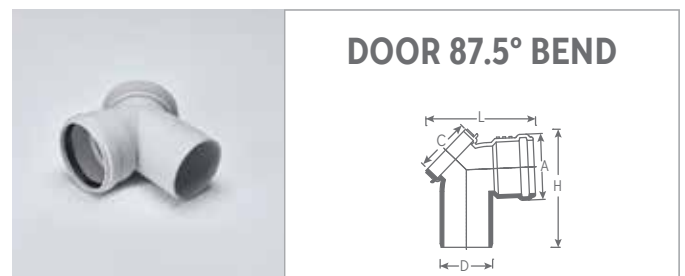

Size (cm)	Product Code	A (mm)	H (mm)	L (mm)	C (mm)	D (mm)	W.T. (mm)	Std. Pkg. (Nos.)
7.5	M242001307	94	168	156	95	75	5.2	27
11.0	M242001309	130	213	199	130	110	5.5	10
12.5	M242001310	147	226	213	130	125	5.5	12
16.0	M242001312	184	273	230	130	160	5.6	07

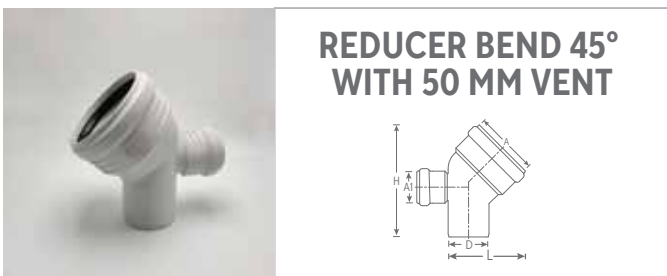

Size (cm)	Product Code	A x A1 (mm)	H (mm)	L (mm)	D (mm)	W.T. (mm)	Std. Pkg. (Nos.)
11.0x7.5	M2420014229	130x68	205	200	75	5.5	28

# SILENCIO PRODUCT RANGE

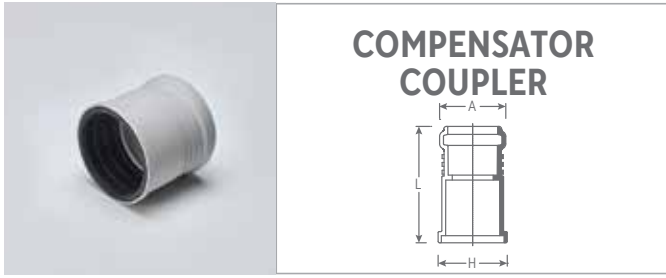

Size (cm)	Product Code	A (mm)	H (mm)	L (mm)	W.T. (mm)	Std. Pkg. (Nos.)
5.0	M242004105	68	71	119	4.2	68
6.3	M242004106	81	121	84	4.2	40
7.5	M242004107	94	95	123	5.2	54
11.0	M242004109	130	132	127	5.5	24
12.5	M242004110	147	136	139	5.5	22
16.0	M242004112	184	185	152	5.6	08

All compensator sockets are pre-assembled with collars and sealing rings.



Size (cm)	Product Code	A x A1 (mm)	H (mm)	L (mm)	D (mm)	W.T. (mm)	Std. Pkg. (Nos.)
11.0x5.0	M242004244	130x68	262	176	110	5.5	12
11.0x6.3	M242000332	130x81	262	186	110	5.5	12
11.0x7.5	M242004229	130x94	262	209	110	5.5	10
12.5x11.0	M242004234	147x130	280	230	125	5.5	10
16.0x7.5	M242004235	184x94	311	261	160	5.6	06
16.0x11.0	M242004231	184x130	311	271	160	5.6	05

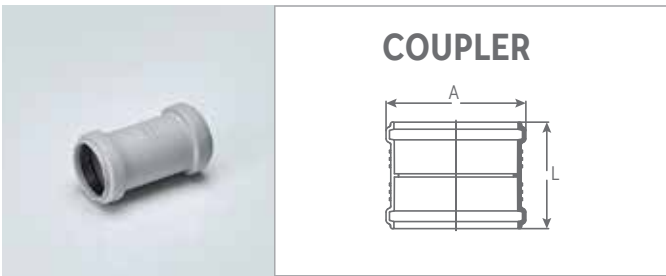

Size (cm)	Product Code	A (mm)	L (mm)	W.T. (mm)	Std. Pkg. (Nos.)
4.0	M242001604	54	95	2.0	125
20.0	M242001614	227	173	6.2	08

Connecting element between pipes as well as between pipes and fittings.

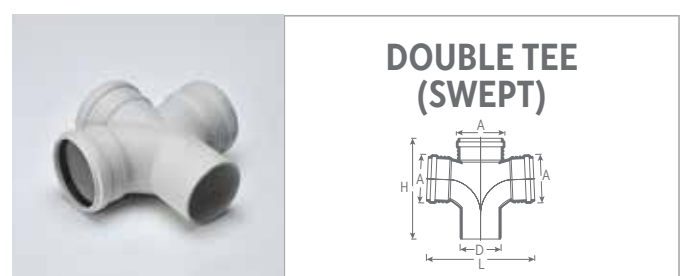

Size (cm)	Product Code	A (mm)	H (mm)	L (mm)	D (mm)	W.T. (mm)	Std. Pkg. (Nos.)
11.0	M242005409	130	270	290	110	5.5	06

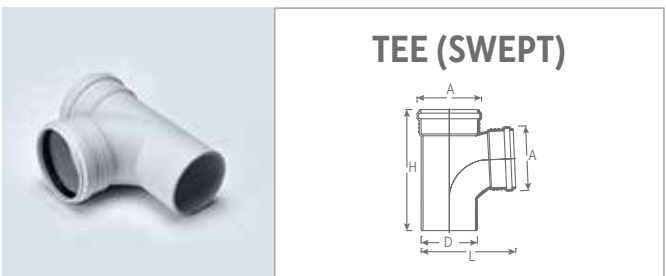

Size (cm)	Product Code	A (mm)	H (mm)	L (mm)	D (mm)	W.T. (mm)	Std. Pkg. (Nos.)
#4.0	M242000104	54	145	102	40	2.0	55
#5.0	M242000105	68	175	115	50	4.2	35
#6.3	M242000106	81	191	130	63	4.2	27
7.5	M242000907	94	222	161	75	5.2	17
11.0	M242000909	130	270	210	110	5.5	10
12.5	M242000910	147	304	238	125	5.5	09
16.0	M242000912	184	345	281	160	5.6	04
20.0	M242000914	227	417	353	200	6.2	02

# without swept

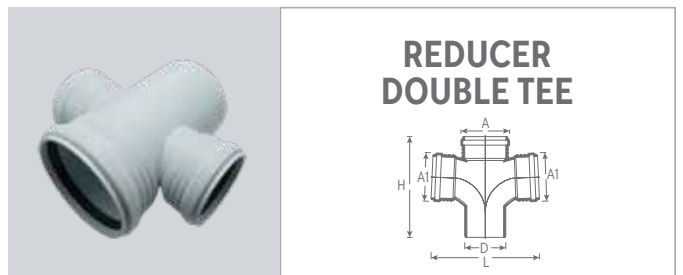

Size (cm)	Product Code	A x A1 (mm)	H (mm)	L (mm)	D (mm)	W.T. (mm)	Std. Pkg. (Nos.)
16.0 X 11.0	M242005431	184x130	283	312	160	5.6	04

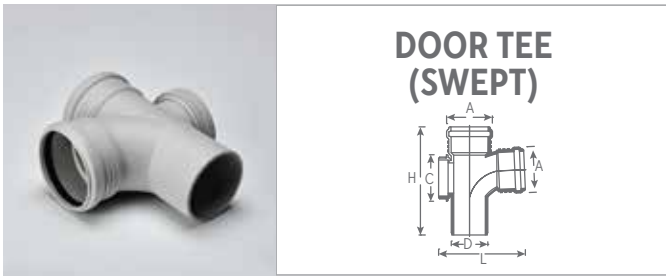

Size (cm)	Product Code	A (mm)	H (mm)	L (mm)	C (mm)	D (mm)	W.T. (mm)	Std. Pkg. (Nos.)
7.5	M242001007	94	222	178	95	75	5.2	15
11.0	M242001009	130	270	230	130	110	5.5	07
12.5	M242001010	147	304	255	130	125	5.5	08
16.0	M242001012	184	345	297	130	160	5.6	04

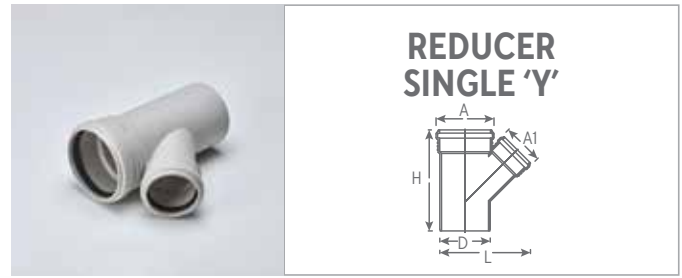

Size (mm)	Product Code	A x A1 (mm)	H (mm)	L (mm)	D (mm)	W.T. (mm)	Std. Pkg. (Nos.)
11.0x7.5	M242002129	130x94	255	218	110	5.5	15
12.5x11.0	M242002134	147x130	309	261	125	5.5	08
16.0x11.0	M242002131	184x130	321	299	160	5.6	05



Size (cm)	Product Code	A x A1 (mm)	H (mm)	L (mm)	C (mm)	D (mm)	W.T. (mm)	Std. Pkg. (Nos.)
11.0x5.0	M242004344	130x68	262	196	130	110	5.5	09
11.0x6.3	M242004332	130x81	262	206	130	110	5.5	08
11.0x7.5	M242004329	130x94	257	229	130	110	5.5	08
12.5x11.0	M242004334	147x130	280	248	130	125	5.5	08
16.0x7.5	M242004335	184x94	311	277	130	160	5.6	05
16.0x11.0	M242004331	184x130	311	287	130	160	5.6	04

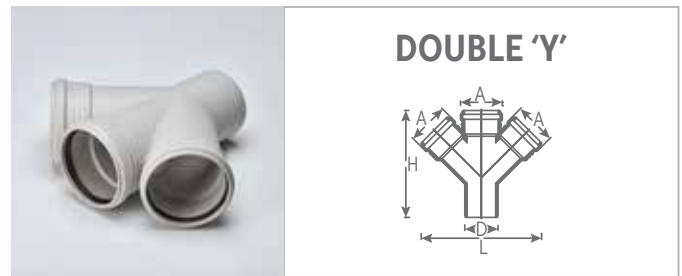

Size (cm)	Product Code	A (mm)	H (mm)	L (mm)	D (mm)	W.T. (mm)	Std. Pkg. (Nos.)
7.5	M242002307	94	241	270	75	5.2	12
11.0	M242002309	130	301	358	110	5.5	08
12.5	M242002310	147	331	401	125	5.5	04
16.0	M242002312	184	392	494	160	5.6	03

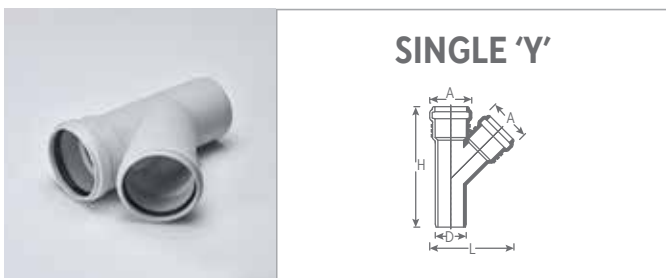

Size (cm)	Product Code	A (mm)	H (mm)	L (mm)	D (mm)	W.T. (mm)	Std. Pkg. (Nos.)
4.0	M242001904	54	161	115	40	1.9	30
5.0	M242001905	68	195	135	50	4.2	29
6.3	M242001906	81	217	160	63	4.2	25
7.5	M242001907	94	241	182	75	5.2	18
11.0	M242001909	130	301	244	110	5.5	08
12.5	M242001910	147	331	274	125	5.5	06
16.0	M242001912	184	392	338	160	5.6	04
20.0	M242001914	227	461	419	200	6.2	02

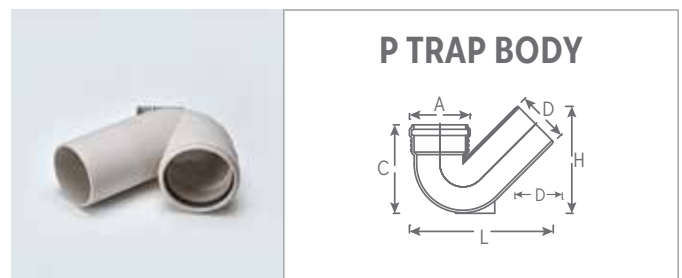

Size (cm)	Product Code	A (mm)	H (mm)	L (mm)	C (mm)	D (mm)	W.T. (mm)	Std. Pkg. (Nos.)
7.5x7.5	M242003507	94	164	219	150	75	5.2	25
11.0x11.0	M242003509	130	229	308	190	110	5.5	12

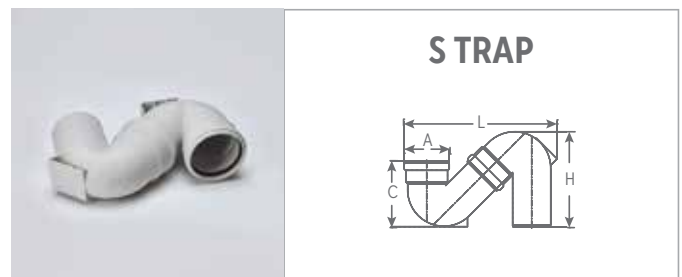

Size (cm)	Product Code	A (mm)	H (mm)	L (mm)	C (mm)	D (mm)	W.T. (mm)	Std. Pkg. (Nos.)
11.0x11.0	F242003709	130	230	400	190	110	5.5	06

# SILENCIO

## PRODUCT RANGE



**MULTY FLOOR TRAP  
HIGH RISER  
(SPIGOT TYPE)  
50 mm OPEN**

Size (cm)	Height (inch)	Product Code	A (mm)	H (mm)	L (mm)	D (mm)	d (mm)	W.T. (mm)	Std. Pkg. (Nos.)
11.0x7.5x(3)5.0	6	M242005709	127	165	230	75	66	3.0	12

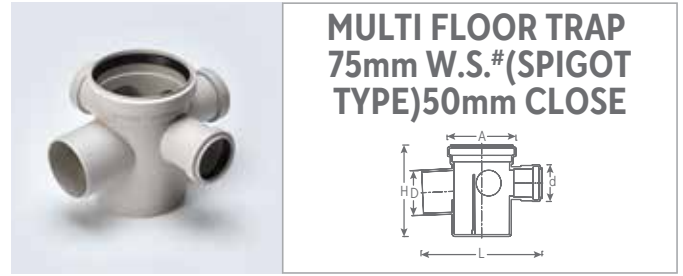

**MULTY FLOOR TRAP  
75mm W.S.#(SPIGOT  
TYPE)50mm CLOSE**

Size (cm)	Height (inch)	Product Code	A (mm)	H (mm)	L (mm)	D (mm)	d (mm)	W.T. (mm)	Std. Pkg. (Nos.)
11.0x7.5x(3)5.0	7	M242006209	127	190	230	75	66	3.5	12

W.S# - Water Seal



**MULTY FLOOR TRAP (SPIGOT TYPE)  
50 mm OPEN**

Size (cm)	Height (inch)	Product Code	A (mm)	H (mm)	L (mm)	D (mm)	d (mm)	W.T. (mm)	Std. Pkg. (Nos.)
11.0x7.5x(3)5.0	6	M242005609	127	165	230	75	66	3.0	12



**MULTY FLOOR TRAP HIGH RISER  
50 mm OPEN**

Size (cm)	Height (inch)	Product Code	A (mm)	H (mm)	L (mm)	d (mm)	W.T. (mm)	Std. Pkg. (Nos.)
11.0x(3)5.0	7	M242005909	127	190	180	66	3.5	12



**MULTY FLOOR TRAP SPIGOT TYPE  
50mm CLOSE**

Size (cm)	Height (inch)	Product Code	A (mm)	H (mm)	L (mm)	D (mm)	d (mm)	W.T. (mm)	Std. Pkg. (Nos.)
11.0x7.5x5.0	6	M242006309	127	165	230	75	66	3.0	12



**MULTY FLOOR TRAP HIGH RISER  
50 mm CLOSE**

Size (cm)	Height (inch)	Product Code	A (mm)	H (mm)	L (mm)	d (mm)	W.T. (mm)	Std. Pkg. (Nos.)
11.0x(3)5.0	7	M242006009	127	190	180	66	3.5	12

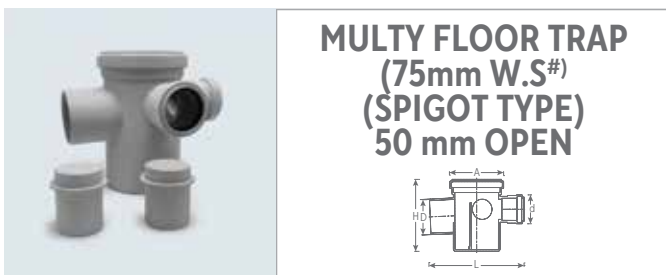

**MULTY FLOOR TRAP  
(75mm W.S#)  
(SPIGOT TYPE)  
50 mm OPEN**

Size (cm)	Height (inch)	Product Code	A (mm)	H (mm)	L (mm)	D (mm)	d (mm)	W.T. (mm)	Std. Pkg. (Nos.)
11.0x7.5x(3)5.0	7	M242005809	127	190	230	75	66	3.5	12

W.S# - Water Seal

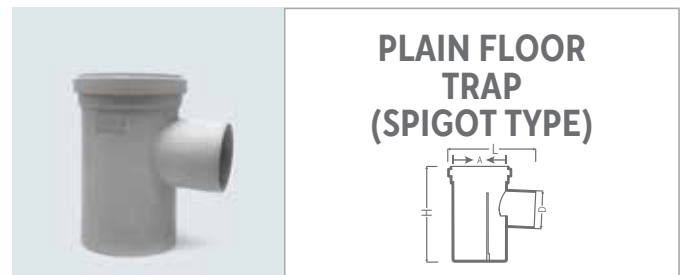

**PLAIN FLOOR TRAP  
(SPIGOT TYPE)**

Size (cm)	Height (inch)	Product Code	A (mm)	H (mm)	L (mm)	D (mm)	W.T. (mm)	Std. Pkg. (Nos.)
11.0x7.5	6	M242006409	127	165	175	75	3.5	12
11.0x7.5	7	M242006909	127	190	175	75	3.5	12

W.S. WATER SEAL, 7"W.S. - 75 mm, 6" W.S. - 50 mm

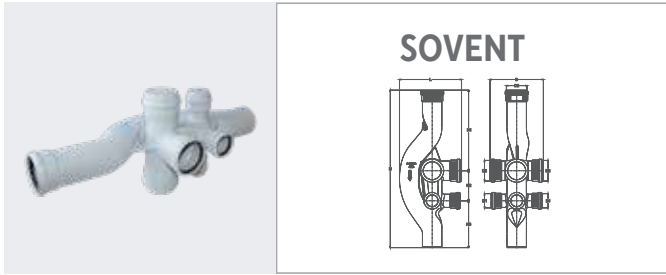

Size (cm)	Product Code	D1 (mm)	D2 (mm)	H (mm)	H1 (mm)	H2 (mm)	H3 (mm)	L (mm)	B (mm)	Std. Pkg. (Nos.)
11.0	M2420015409	75	110	890	470	165	265	350	325	01

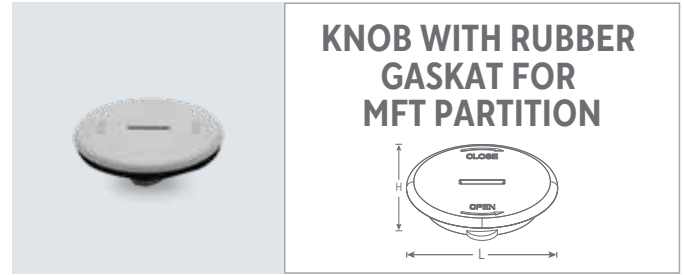

Size (cm)	Height (inch)	Product Code	H (mm)	L (mm)	W.T. (mm)	Std. Pkg. (Nos.)
11.0	6&7	M242005100	10	53	2.6	01

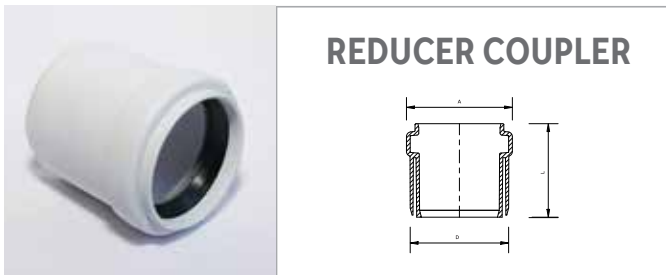

Size (cm)	Product Code	A (mm)	L (mm)	D (mm)	W.T. (mm)	Std. Pkg. (Nos.)
5.0x4.0	M242004841	48	54	50	4.3	200

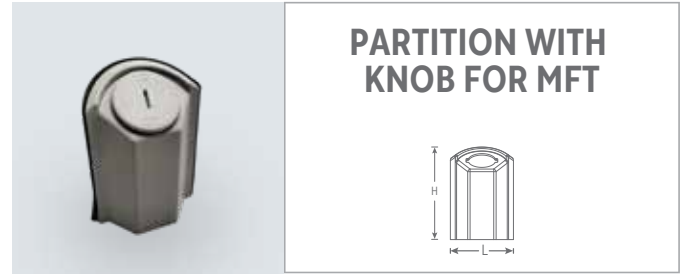

Size (cm)	Height (inch)	Product Code	H (mm)	L (mm)	W.T. (mm)	Std. Pkg. (Nos.)
11.0	6	M242005000R	113	95	2.6	100
11.0	7	M242006100R	138	95	2.6	75

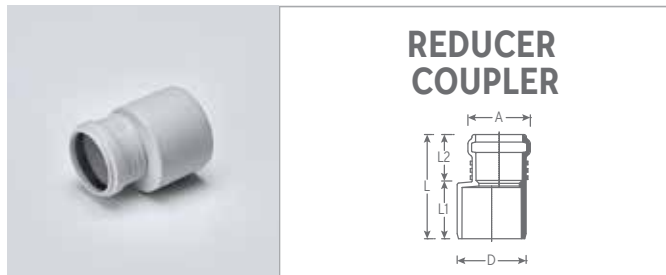

Size (cm)	Product Code	A (mm)	L (mm)	L1 (mm)	L2 (mm)	D (mm)	W.T. (mm)	Std. Pkg. (Nos.)
5.8x5.0	F242004836	65	137	41	68	58	3.5	60
6.3x5.0	M242004839	68	113	60	52	63	4.2	72
7.5x5.0	M242004837	68	113	63	50	75	5.2	55
7.5x6.3	M242004836	81	115	60	54	75	4.2	50
7.8x7.5	F242004835	91	187	61	73	78	4.0	20
11.0x5.0	M242004844	68	138	88	50	110	5.5	40
11.0x6.3	M242004832	81	140	825	57	110	4.2	36
11.0x7.5	M242004829	94	139	84	55	125	5.5	36
12.5x7.5	M242004893	91	146	88	58	125	5.5	27
12.5x11.0	M242004834	130	166	88	77	125	5.5	27
16.0x11.0	M242004831	130	196	136	60	160	5.6	15
16.0x12.5	M242004833	147	196	94	102	160	5.5	21
20.0x11.0	M242004846	130	198	138	60	200	6.2	12
20.0x16.0	M242004847	184	202	131	71	200	6.2	12

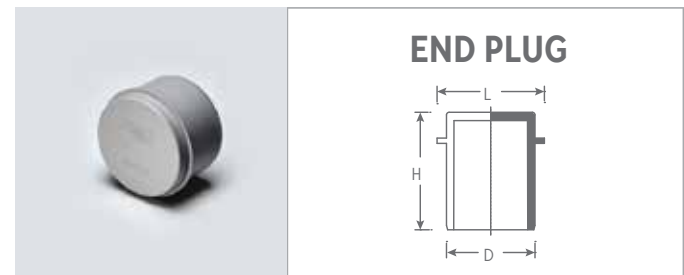

Size (cm)	Product Code	H (mm)	L (mm)	L (mm)	W.T. (mm)	Std. Pkg. (Nos.)
5.0	M242002905	66	60	50	4.2	144
6.3	M242002906	79	134	63	4.2	100
7.5	M242002907	69	84	75	5.2	80
11.0	M242002909	74	119	110	5.5	46
12.5	M242002910	67	73	125	5.5	30
16.0	M242002912	52	175	160	5.6	22
20.0	M242002914	60	216	200	6.2	12



# SILENCIO PRODUCT RANGE

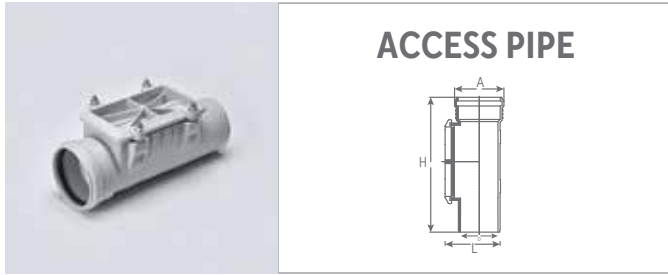

**ACCESS PIPE**

Size (cm)	Product Code	A (mm)	H (mm)	L (mm)	D (mm)	W.T. (mm)	Std. Pkg. (Nos.)
11.0	M242005309	130	356	148	110	5.5	06
12.5	M242005310	147	370	145	125	5.5	04
16.0	M242005312	184	400	200	160	5.6	04
20.0	M242005314	227	480	240	200	6.2	02

With rectangular access lid.

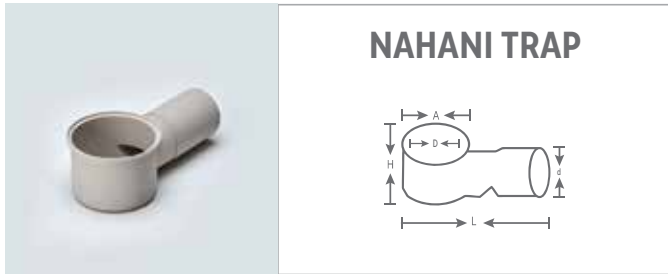

**NAHANI TRAP**

Size (cm)	Product Code	A (mm)	H (mm)	L (mm)	D (mm)	d (mm)	W.T. (mm)	Std. Pkg. (Nos.)
11.0x7.5	M242003129	126	85	250	110	75	3.2	30
11.0x9.0	M242003143#126	100	250	110	110	90	3.0	Shrt. Intr.
11.0x11.0	M242003109#126	120	260	110	110	110	2.8	Shrt. Intr.



**EXT. PIECE FOR NAHANI TRAP**

Size (cm)	Product Code	H (mm)	L (mm)	D (mm)	W.T. (mm)	Std. Pkg. (Nos.)
11.0	M2420014409#	176	117	110	3.5	Shrt. Intr.

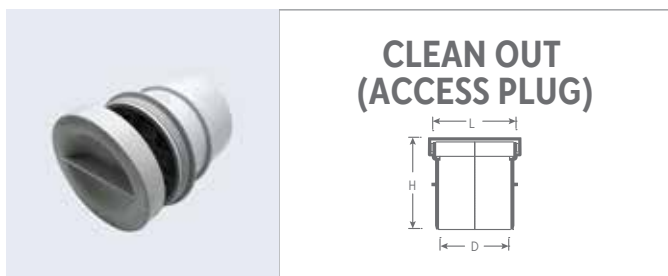

**CLEAN OUT (ACCESS PLUG)**

Size (cm)	Product Code	H (mm)	L (mm)	D (mm)	W.T. (mm)	Std. Pkg. (Nos.)
11.0	M2420010109	122	130	110	5.5	27



**COMPENSATOR RUBBER RING**

Size (cm)	Product Code	Std. Pkg. (Nos.)
5.0	RM06510050	01
6.3	RM06510063	01
7.5	RM06510075	01
11.0	RM06510110	01
12.5	RM06510125	01
16.0	RM06510160	01

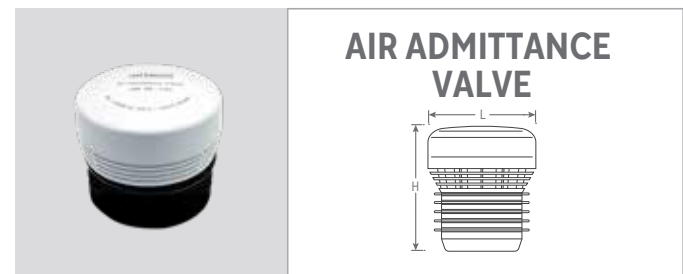

**AIR ADMITTANCE VALVE**

Size (cm)	Item Type	Product Code	H (mm)	L (mm)	Std. Pkg. (Nos.)
3.2-6.3	Mini	HYPERAIR-32.63	78	70	140
7.5-11.0	Maxi	HYPERAIR-70.110	106	125	12

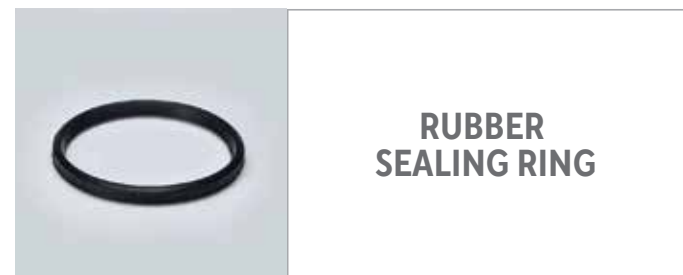

**RUBBER SEALING RING**

Size (cm)	Product Code	Std. Pkg. (Nos.)
4.0	RM06311040	01
5.0	RM06311050	01
6.3	RM06311063	01
7.5	RM06311075	01
11.0	RM06311110	01
12.5	RM06311125	01
16.0	RM06311160	01
20.0	RM06311200	01



**RUBBER O RING  
FOR ACCESS INNER  
DOOR**

Size (cm)	Product Code	Std. Pkg. (Nos.)
7.5	RM06590010#	Shrt. Intr.
11.0	RM06590011#	Shrt. Intr.



**RUBBER GASKET  
FOR ACCESS INNER  
DOOR**

Size (cm)	Product Code	Std. Pkg. (Nos.)
7.5	RM06590002#	Shrt. Intr.
11.0	RM06590004	01

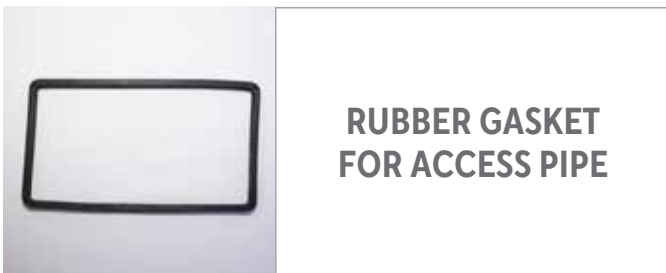

**RUBBER GASKET  
FOR ACCESS PIPE**

Size (cm)	Product Code	Std. Pkg. (Nos.)
11.0	RM06590006	01
16.0	RM06590007	01
20.0	RM06590008#	Shrt. Intr.

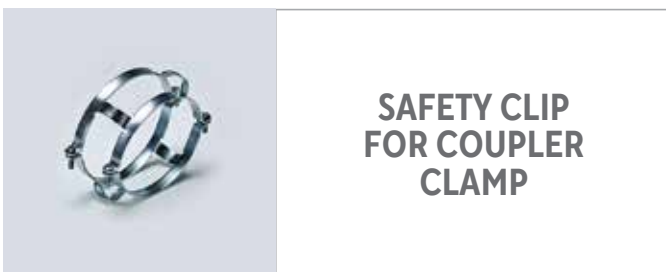

**SAFETY CLIP  
FOR COUPLER  
CLAMP**

Size (cm)	Product Code	Pkg.(Nos.) Std. Mast.
7.5	SC-075-CC	10 100
11.0	SC-110-CC	10 100
12.5	SC-125-CC#	- -
16.0	SC-160-CC	06 60
20.0	SC-200-CC	05 50



**SAFETY CLIP FOR  
SOCKET PLUG  
(END CAP)**

Size (cm)	Product Code	Pkg.(Nos.) Std. Mast.
7.5	SC-075-EC	10 100
11.0	SC-110-EC	20 80
12.5	SC-125-EC#	- -
16.0	SC-160-EC	06 60
20.0	SC-200-EC	06 60

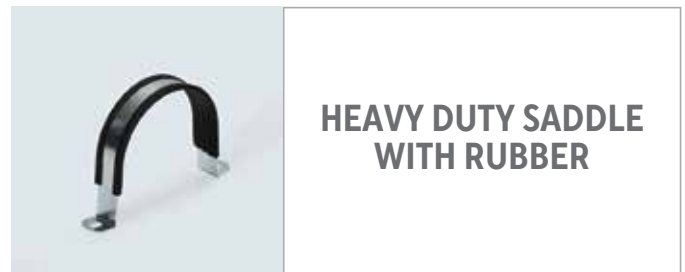

**HEAVY DUTY SADDLE  
WITH RUBBER**

Size (cm)	Product Code	Pkg.(Nos.) Std. Mast.
4.0	T105-012R#	- -
5.0	T105-015R#	- -
6.3	T105-020R	20 200
7.5	T105-025R	32 320
11.0	T105-040R	24 240
16.0	T105-060R	12 120
20.0	T105-080R	03 30



**SOUND  
DAMPENING  
CLAMP**

Size (cm)	Product Code	Pkg.(Nos.) Std. Mast.
7.5	T108-025HR#	- -
11.0	T108-040HR	05 25
16.0	T108-060HR	04 20
20.0	T108-080HR#	- -

# Shortly Introducing

# SILENCIO PRODUCT RANGE



## SPLIT CLAMPS

Size (cm)	Product Code	Pkg.(Nos.) Std. Mast.
4.0	T101-012R*	25 250
5.0	T101-015R*	25 250
6.3	T101-020R*	25 250
7.5	T101-025R*	25 200
7.5	T101-025HR**	06 60
11.0	T101-040R*	10 100
11.0	T101-040HR**	09 90
16.0	T101-060R*	10 100
16.0	T101-060HR**	06 60
20.0	T101-080R*	01 50
20.0	T101-080HR***	- 01

\*\*Bracket/ Clamp with heavy duty rubber insert.

\*Bracket / Clamp with rubber insert



## HANGING CLAMP

Qty. (cm)	Product Code	Pkg.(Nos.) Std. Mast.
11.0	T107-040	05 05



## PIPE JOINT LUBRICANT

Qty. (gm)	Product Code	Std. Pkg. (Nos.)
100	STINS-100	100
250	STINS-250	40
500	STINS-500	86



## RESCUE TAPE

Size (ft.)	Product Code	Std. Pkg. (Nos.)
5	M005601010	120
5	M005601015	120
5	M005601005	120
10	M005601025	120
10	M005601030	120
10	M005601020	120
15	M005601040	120
15	M005601045	120
15	M005601035	120



## BONDSET FAST SETTING

Qty. (gm)	Product Code	Std. Pkg. (Nos.)
50	M000702051	01
100	M000702050	01



## PTFE TAPE

Size (metre)	Product Code	Std. Pkg. (Nos.)
4	M003302004	01
8	M003302007	01
8	M003302017	01

# INSTALLATION PROCEDURE

## PIPE CUTTING

Astral Silencio can be cut simply with a professional pipe cutter or a saw. Make sure that the cut is at a 90° angle on the pipe axis. Remove any burrs, cutting residues, sharp edges, and clean the pipe end.

For making a connection to the compensator or end of the compensator, pipe ends may not be chamfered. For making a connection to other fittings, the pipe requires to be chamfered.



## PUSH-FIT JOINTS WITHOUT COMPENSATOR SOCKET

To cope with variations in length due to thermal factors in pipe-fitting connections, when the maximum pipe length is 3 metre / 9.5 feet, a maximum 10 mm / 0.4 inches slid out of the sleeve has to be considered.

For push-fit connections between fittings, no variations in length due to thermal factors have to be considered, and it is therefore possible to slot the fittings completely.

The push-fit coupling is done as follows:

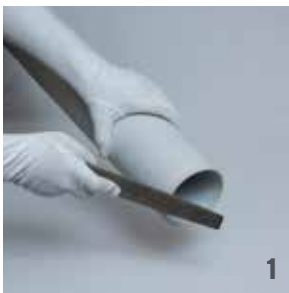

Check the position and the condition of the lip seal in the coupler channel. If necessary, clean the fitting and the gasket. Clean the push-fit end of the pipe and the fitting.



Apply a thin uniform layer of Astral lubricant on the end of the coupling. Do not use oil or grease.



Place the end into the coupler and push in firmly.



Slide the pipe and not the fitting just 10 mm / 0.4 inches out of the coupling. When pipes are positioned vertically, leave space of 10 mm / 0.4 inches to avoid slipping and for elimination of the dilatation. Then fix the individual pipes with collars immediately after assembly.

## JOINTS WITH THE COMPENSATOR SOCKET

The Astral Silencio compensator socket is used to connect two pipes as well as a pipe and the fitting where compensation for axial movement is required. For conventional plastic soil and waste pipe systems, the expansion margin is created by marking and withdrawing the pipe to the expansion length. This is not required in case of Astral Silencio, as the compensator socket adapts to temperature changes in the system. This doesn't only save working time, but also gives additional technical security to the system.

## STEPS FOR JOINING COMPENSATOR SOCKET

When making the connection with the compensator socket the following instructions should be adhered to:



1 Pull the expansion collar from the compensator socket.



2 Push the expansion collar over the pipe end.



3 Apply lubricant inside compensator socket of the fitting. Never use oil or grease.



4 Apply and distribute lubricant evenly on outside of elastomeric compensator collar. Push the fitting over compensator collar to full insertion depth.



5 Check final position of compensator collar. Ensure pipe end is flushed with gasket tip.

# FIXATION

In principle, Astral Silencio soil and waste system should be installed tension-free and with free lateral allowance for temperature compensation. Use rubber-line brackets. The pipe brackets should have inserts of corrugated rubber and should be fixed to the wall using screws and plastic plugs. For pipe systems in which inner-pressures can arise, the joints have to be secured to prevent them from sliding apart and deviating from the center axis. The Astral safety clips prevent the joints from sliding apart. Alternatively the fixing brackets can be arranged appropriately to achieve the same effect.

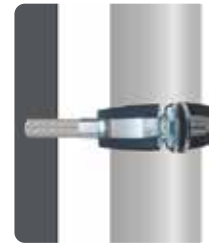

VERTICAL SUPPORT

## FIXING BRACKET

The fixed bracket creates a fixed point in the pipe system. With fixed brackets, the pipe or fitting cannot be moved through the bracket after the screws are tightened (no longitudinal movement is possible). In order to prevent sliding down of the vertical stack, each individual pipe length must be secured on one point by a fixed bracket. Fittings or groups of fittings must always be secured as fixed points. Also every horizontally installed pipe should always be fixed with one fixed bracket. All remaining pipe brackets – in the vertical as well as in the horizontal installation, must be sliding brackets. The prescribed bracket distances should not be exceeded.

## SLIDING BRACKET

By using sliding brackets, the pipe still can be moved through the bracket after the screws are tightened (longitudinal movement is possible once installed).



CORRECT



INCORRECT

External heating of Astral Silencio Pipes should be limited by heat insulating the source; e.g. central heating pipes as well as hot tap water pipes. Pipe and shaft dimensions are to be taken from the table below.

Size mm (inches)	OD of Pipe $d_a$ (mm)	OD of Socket $d_m$ (mm)	Min. Required Spacing*
40 (1½)	40	54	125
50 (1½)	50	68	125
63 (2)	63	81	140
75 (2½)	75	95	155
110 (4)	110	130	190
125 (5)	125	147	210
160 (6)	160	184	244
200 (8)	200	228	288

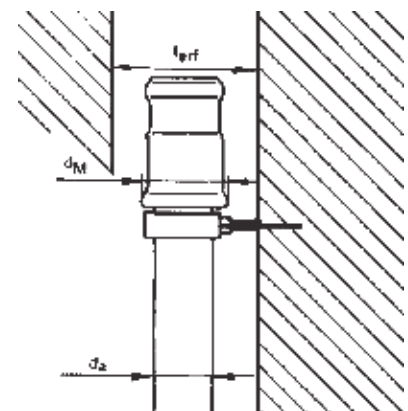

\* The stated depths are not including pipe crossings

Space requirements for Astral Silencio pipes Size 40 – Size 200 mm.



## INSTALLATION IN CONCRETE

Astral Silencio pipes and fittings can be cast in concrete. Thermal induced lateral movements have to be dealt according to the instructions.

- Attach pipe component in such a way that a change in position during concrete application is prevented.
- Seal the sleeve gap with adhesive strips to prevent the penetration of concrete.
- Seal the pipe opening before concrete application.

## WALL AND CEILING INSTALLATIONS

Wall and ceiling installations are to be made moisture tight and should also be sound-absorbing and leakproof. If a flooring substitute is to be applied, then the exposed pipe components are to be secured in protecting tubes or encased in soft materials (e. g. glass wool or foam material).

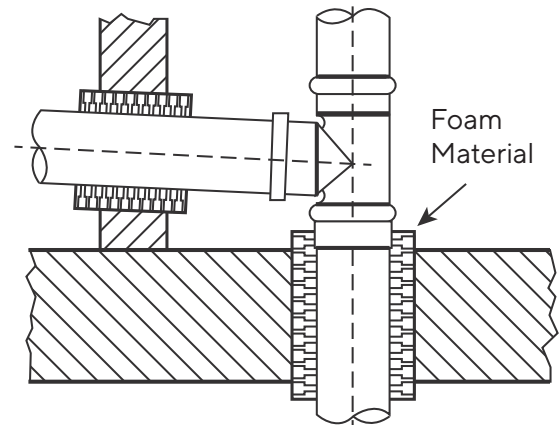

## ROOF DRAINAGE PIPES

Roof drainage pipes projected through living, sleeping and working rooms can be installed as shown in the diagram. The specific area weight of the casting should be at least equal to the wall and preferably for both at least 220 kg/m<sup>2</sup>. Although the formation of condensation on the outside of Astral Silencio pipes is less than that of metallic pipes, it is recommended to insulate the pipes and fittings.

## BELOW-GROUND PIPING AND COLLECTOR PIPES

Below-ground piping is normally connected to downpipes or directly into wastewater facilities located at basement level. Such piping is normally to be found buried within the confines of the building or below the foundation. Collecting pipes are installed above-ground and are used to collect wastewater from downpipes or other connecting pipework.

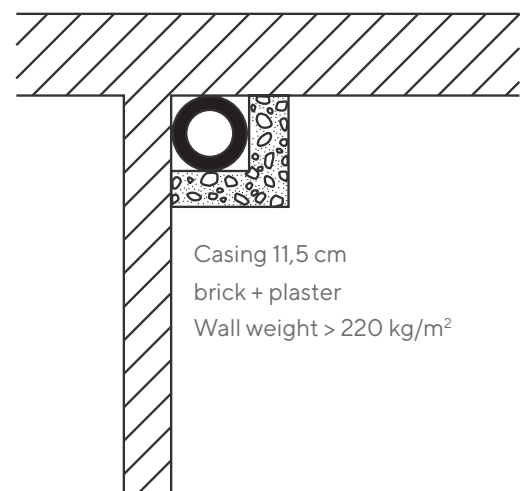

# ARRANGEMENTS OF THE BRACKETS

During installation of Astral Silencio pipes, the following should be considered:

- In case of horizontal installation, the pipe bracket distances are  $10 \times$  the outside diameter of the pipe. This becomes, in case of vertical pipe installation, depending on outside diameter, 1-2 metre (3 to 6 feet)
- Generally pipe brackets should not be installed in impact areas (e.g. diameter reductions and changes of directions in the system)
- Pipe brackets are to be fixed to building materials with high specific area weight
- For stacking pipes in open mounting shafts and high rooms (storey height over 2.5 metre / 8 feet), It is advised to use one fixed bracket and one sliding bracket per pipe length
- The fixed bracket must be installed directly above the fitting at the bottom of the pipe end. The sliding bracket must be installed at a distance of maximum of 2 metre / 6 feet above the fixed bracket
- In multiple storey buildings (from 3 storeys and more) the stack pipes of Size 100 or bigger must be secured by additional fixing (stack pipe support) against sliding. In this case, we advise using the Astral Silencio socketed short length with a fixed bracket. Stack segments with fittings or short pipes are to be secured in such short distances with pipe brackets, so that they cannot slide apart

In exceptional cases, where connecting elements other than the compensator socket are used (e.g. double socketed sleeve), per maximum allowable pipe length 3 metre / 9.8 feet, one fixed bracket and one sliding bracket should be installed in line as per the illustrations shown on this page. The double socketed sleeves are to be fixed

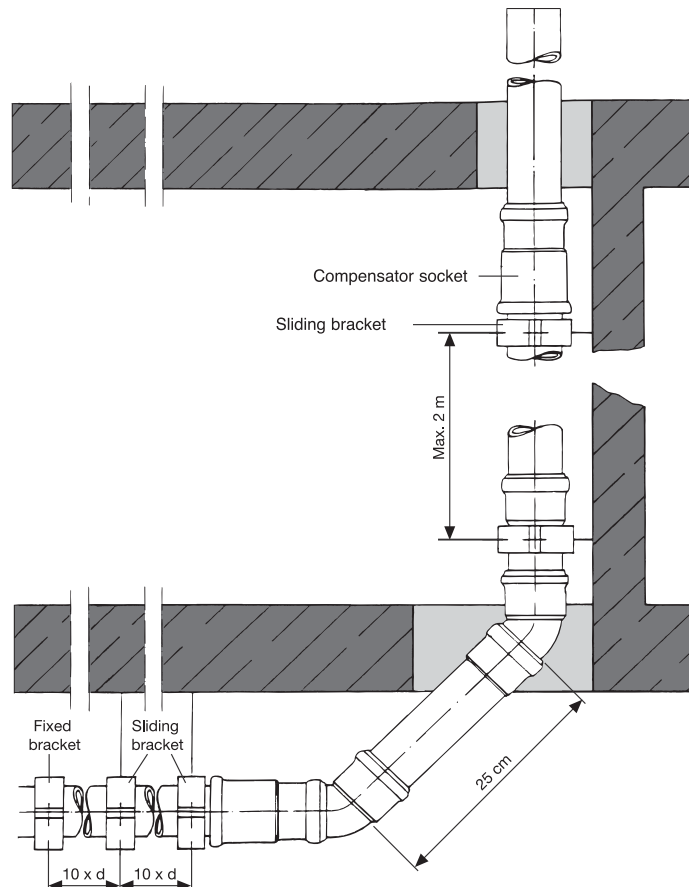

# SUPPORT SPACING DISTANCES

## VERTICAL PIPE ROUTING

As a principle, 2 brackets are fitted for each floor-level. One fixed bracket is fitted to the pipe running below a socket in the lower floor level. The sliding bracket is attached loosely to the plain pipe to allow the linear expansion of the pipe run.

## HORIZONTAL PIPE ROUTING

The pipe run must be secured against lateral shifting or axial movement in the proximity of all points of directional changes.

## MAXIMUM DISTANCES BETWEEN THE BRACKETS FOR HORIZONTAL AND VERTICAL INSTALLATION

Pipe Size (external diameter) mm (inches)	Max. brackets distance for Horizontal installing - L Max Metre (feet)	Max. brackets distance for Vertical installing - L Max Metre (feet)
40 (1¼)	0.7 (2.2')	1.30 (4.2')
50 (1½)	0.80 (2.6')	1.50 (4.9')
63 (2)	0.95 (3.1')	1.75 (5.7')
75 (2½)	1.10 (3.6')	2.00 (6.5')
110 (4)	2.00 (6.5')	2.00 (6.5')
125 (5)	2.00 (6.5')	2.00 (6.5')
160 (6)	2.00 (6.5')	2.00 (6.5')
200 (8)	2.40 (7.8')	2.00 (6.5')

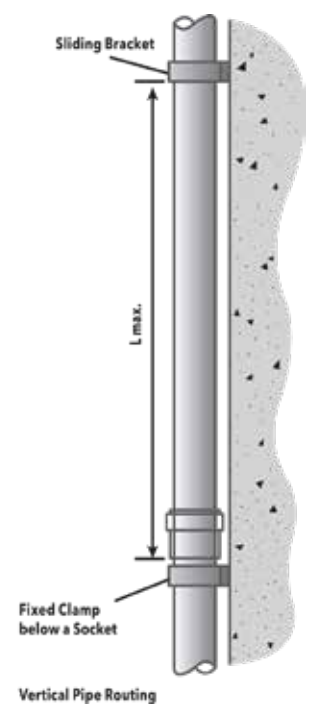
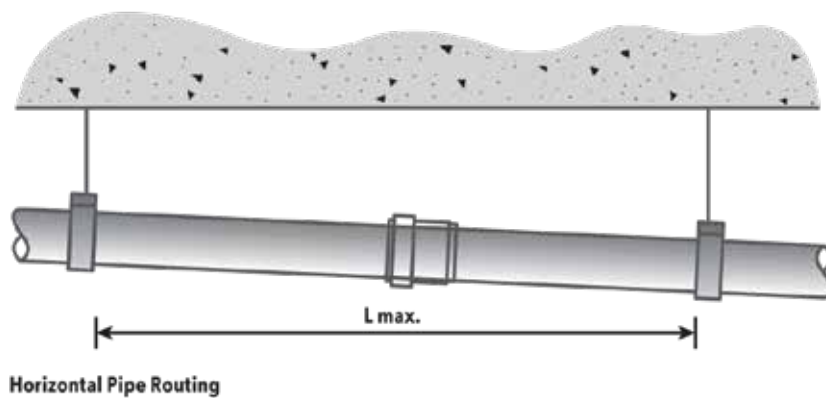

In case of the possibility of flooding of the system, it is advisable to use the rigid support system as mentioned in the below drawing. It is also advisable to use the safety clip for the coupler/socket joint. Safety clips can be used at the bottom diversion of a high-rise stack. It can provide extra protection to the joint against flow coming at high velocity from the top floors of a high-rise stack.

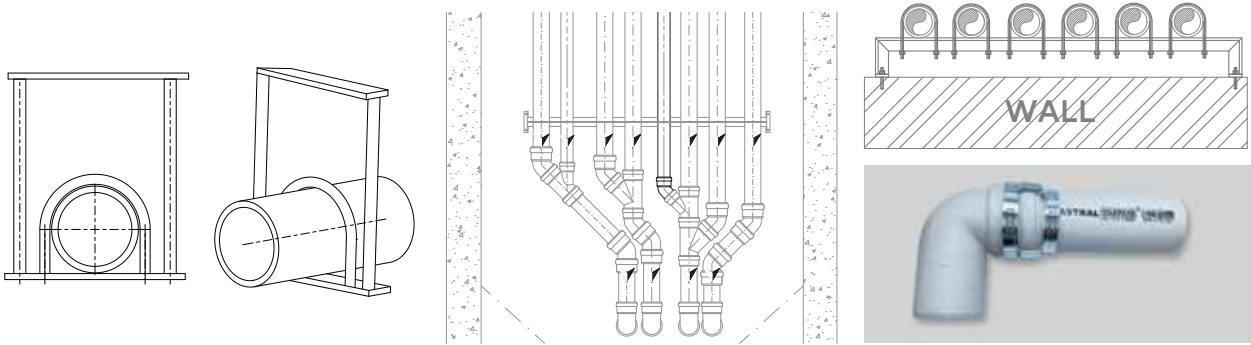

## LOADING AND TRANSPORTATION



When loading, pipes and fittings should be handled in such a way that no damage occurs during transportation. Wherever possible, during transportation the pipes should rest in their entire length on top of each other, so that sagging can be avoided. Avoid sudden and abrupt stresses on pipes and fittings, especially with temperatures in the frost range.

## UNLOADING AND STORAGE

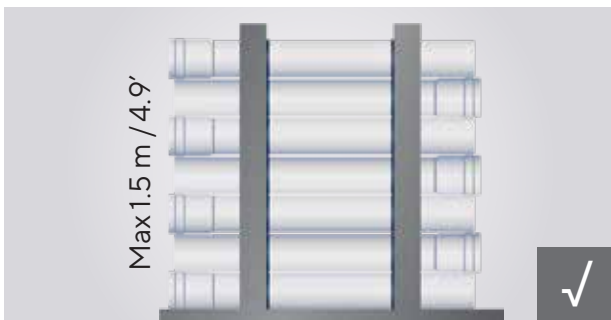

Unloading is to be carried out with appropriate care. Do not drop pipes or drag them over the ground. Furthermore, make sure that the pipes are not pulled over sharp edges (e.g. tailgate). Unpalletized pipes should not be stacked higher than 1.5 m. (4.9') pipe stacks must be secured against rolling apart.

Fittings are packed in cartons. Protect carton-packed fittings against moisture.

# NOTE

The Polypropylene pipe has a service life of 50 years which is similar to the average age of an apartment. The polypropylene pipe after its service life can be recycled as per the general process of pipe recycling. The recycled pipes can be used in PP production thereby reduces the demand of virgin material.

The pipe can also be sent to the incineration plant or landfills as per the requirement

## OUTDOOR EXPOSURE

Astral Silencio pipes and fittings are designed to withstand outdoor storage:

Longer outdoor storage periods and intense exposure to direct sunlight might lead to discolouration of the surface and to a slight deterioration of the mechanical material properties.

## CLEANING AND MAINTENANCE



### CLEANING THE WASTE PIPE SYSTEM

Installing access pipes enables mechanical cleaning of the waste pipe system. Door fittings give the ability to access the cleaning at any point in the system.



### P TRAP SIPHON

Astral Silencio P trap Siphon provides 50 mm / 0.2 inches water seal to prevent foul odour coming out of the drainage line. The P trap Siphon is to be used together with Size 110 bend 45°.

While installing the P trap, it is important to install the pipe support properly to ensure the safe operation of drainage system.



### SOCKET PLUG / SAFETY CLIP

The socket plug can be used to plug-off the pipe ends if they are not in use. The socket plug is to be used together with the securing clip to ensure a safe and tight jointing.



### END PLUG

These blind plugs are easy to mount to the inlets of the Floor Trap and secure a leakage-free sealing of unused connections to the Floor Trap.



### FLOOR TRAP

The highly functional Floor Trap design by Astral complies with low noise system.

Seal Construction The proven seal construction gives not only the top inlet but inlets and outlets on all branches to perform with the reliability and maintain functionality.

Baffle Partition Baffle construction is air-tight at all working condition of trap. Specially designed inspection plug enables to access the area under the baffle in order to inspect and clean this area.

# CHEMICAL RESISTANCE CHART

## PIPE AND FITTING

The specifications are used for the initial orientation of the chemical resistance of the material (not of the possible influence of the corrosive agent) and cannot simply be applied to all usage scenarios. Mechanical behaviour can be impaired in cases where tension and the presence of chemicals occur simultaneously (tension-fracture corrosion).

## RUBBER SEALING RING

The types of rubber used generally exhibit quite good chemical resistance, but components of esters, ketones and aromatic and chlorinated hydrocarbons in sewer water expand heavily, which can lead to damage of the connection.

If in doubt, we recommend testing the suitability of the pipe, fitting and seal material in existing systems or have them checked in a laboratory. Contact our applications department if necessary.

## TABLE LEGEND

r = resistant

cr = conditionally resistant

nr = not resistant

- = not tested

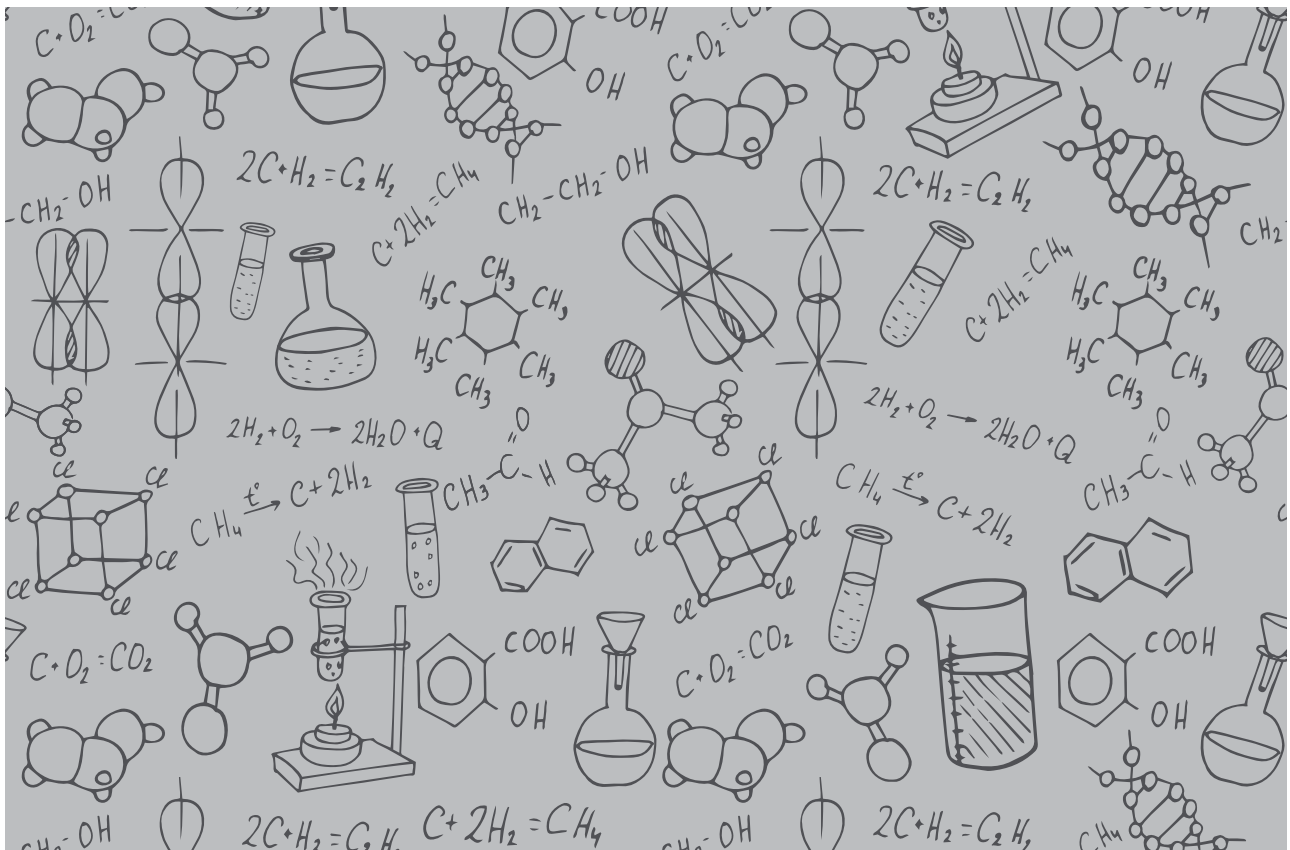

# CHEMICAL RESISTANCE CHART

CHEMICAL	Concentr, %	Temp. °C	Silencio PP
2-Propen-1-ol	96	20	r
	96	60	r
Acetaldehyde + acetic acid	90/10	20	-
Acetaldehyde, aqueous	40	40	r
Acetaldehyde, concentrated	100	20	-
Acetate ether	100	20	-
Acetic acid, aqueous	up to 25	40	r
	up to 25	60	r
	25-60	60	r
	80	40	r
Acetic acid, concentrated	95	40	-
Acetic anhydride	100	20	r
	100	40	cr
	100	60	cr
Acetone	100	20	r
	100	60	r
Acetone, aqueous	traces	20	r
Acronal dispersions	com. avail.	20	-
Acronal solutions	com. avail.	20	-
Acrylic acid ethyl ester	100	20	-
Adipic acid, aqueous	saturated	20	r
	saturated	60	-
Aluminium chloride	diluted	40	r
	diluted	60	r
	saturated	60	r
Aluminium sulfate, aqueous	diluted	40	r
	diluted	60	r
	saturated	60	r
Alums, aqueous	diluted	40	r
	diluted	60	r
	saturated	60	r
Ammonia, gas	100	60	r
Ammonia, liquid	100	20	r
Ammonium chloride, aqueous	diluted	40	r
	diluted	60	r
	saturated	60	r
Ammonium Fluoride, aqueous	up to 20	20	r
	up to 20	60	r
Ammonium hydroxide	warm sat.	40	r
	warm sat.	60	r
Ammonium nitrate, aqueous	diluted	40	r
	diluted	60	r
	saturated	60	r
Ammonium sulfate, aqueous	diluted	40	r
	diluted	60	r
	saturated	60	r
Ammonium sulfide, aqueous	diluted	40	r
	diluted	60	r
	saturated	60	r

CHEMICAL	Concentr, %	Temp. °C	Silencio PP
Aniline hydrochloride, aqueous	saturated	20	r
	saturated	60	r
Aniline, aqueous	saturated	20	r
	saturated	60	r
Aniline, pure	100	20	r
	100	60	r
Animal glue	custom.co	20	r
	custom.co	60	r
Anthraquinonesulfonic acid, aqueous suspension 30			r
Antiformin, aqueous	2	20	-
Antimony chloride, aqueous	90	20	r
Arsenic acid, aqueous	diluted	40	r
	diluted	60	r
	80	40 r	
	80	60 r	
Beef tallow emulsion, sulphonated	com. avail.	20	-
Beer	com. avail.	20	r
Beer colourinzzg agent	com. avail.	60	r
Benzaldehyde, aqueous	0,1	60	-
Benzene	100	20	cr
Benzoic acid, aqueous	any	20	r
	any	40	r
	any	60	r
Bisulphite solution, w/ SO	warm sat.	50	r
Bleaching liquour, containing 12.5 % active chlorine	usage conc.	40	-
	usage conc.	60	cr
Borax, aqueous	diluted	40	r
	diluted	60	r
	saturated	60	r
Boric acid, aqueous	diluted	40	r
	diluted	60	r
	saturated	60	r
Brandy	com. avail.	20	r
Bromine fumes	minimal	20	nr
Bromine, liquid	100	20	nr
Butadiene	100	60	-
Butane, gaseous	50	20	r
Butanediol	up to 100	20	-
Butanediol, aqueous	up to 10	20	r
	up to 10	40	r
	up to 10	60	r
Butanol	up to 100	20	r
	up to 100	40	r
	up to 100	60	cr
Butyl acetate	100	20	cr
Cider	com. avail.	20	r

TABLE LEGEND r=resistant | cr=conditionally resistant | nr=not resistant | -=not tested



# CHEMICAL RESISTANCE CHART

CHEMICAL	Concentr, %	Temp. °C	Silencio PP
Citric acid, aqueous	up to 10	40	r
	up to 10	60	r
	saturated	60	r
Clophene	com. avail.	20	-
	com. avail.	60	-
Coconut fat alcohol	100	20	r
	100	60	cr
Copper Fluoride, aqueous	2	50	r
Copper sulfate, aqueous	diluted	40	r
	diluted	60	r
	saturated	60	r
Cresol, aqueous	up to 90	45	-
Crotonaldehyde	100	20	r
Cyclohexanol	100	20	r
Cyclohexanone	100	20	r
Cyclohexanone	100	20	r
Densodrin W	com. avail.	60	-
Dextrin, aqueous	saturated	20	r
	18	60	r
Diethylether	100	20	cr
Diglycol acid, aqueous	30	60	r
	saturated	20	r
Dimethyl sulfate, aqueous	up to 50	20	r
	up to 50	40	r
	100	40	-
	100	60	-
Dimethylamine, liquid	100	30	-
Disulfuric acid	10	20	nr
Ethanol (fermentation mash)	common	40	r
	common	60	-
Ethanol, aqueous	any	20	r
	96	60	r
Ethanol, denatured (with 2% toluene)	96	20	cr
	common	20	r
Ethyl acetate	100	20	cr
	100	60	nr
Ethylene chloride	100	20	nr
Ethylene oxide, liquid	100	20	-
Exhaust gas, w/COH	any	60	r
Exhaust gas, w/ HF	traces	60	r
Exhaust gas, w/ NOX	traces	60	r
	higher	60	-
	higher	60	-
Exhaust gases, w/S O7H	lower	20	-
	higher	20	nr
Exhaust gases, w/SOH, moist	any	60	r
Exhaust gases, w/ HCl	any	60	r
Exhaust gases, w/ SO	lower	60	r

CHEMICAL	Concentr, %	Temp. °C	Silencio PP
	50	50	-
Fatty acids	100	60	cr
Ferric chloride, aqueous	up to 10	40	r
	up to 10	60	r
	saturated	60	r
Fertilizer salts, aqueous	up to 10	40	r
	up to 10	60	r
	saturated	60	r
Fluorsilicic acid, aqueous	up to 32	60	-
Formaldehyde, aqueous	diluted	40	r
	diluted	60	r
	40	30	r
Formic acid	100	20	r
	100	60	cr
Formic acid, aqueous	up to 50	40	r
	50	60	r
Frigen	100	20	cr
Fruit pulp	custom. conc	20	r
Glucose, aqueous	saturated	20	r
	saturated	60	r
Glycerine, aqueous	any	60	r
Glycine, aqueous	10	40	r
Glycol, aqueous	com. avail.	60	r
Glycolic acid, aqueous	37	20	r
Hexantriol	com. avail.	60	r
Hydrobromic acid, aqueous	up to 10	40	r
	up to 10	60	r
	48	60	r
Hydrochloric acid, aqueous	up to 30	40	r
	up to 30	60	r
	over 30	20	r
	over 30	60	r
Hydrofluoric acid, aqueous	up to 40	20	r
	40	60	r
	60	20	r
	70	20	r
Hydrogen	100	60	r
Hydrogen peroxide, aqueous	up to 30	20	r
	up to 20	50	r
Hydrogen phosphide	100	20	-
Hydrogen sulfide, dry	100	60	r
Hydrogen sulfide, aqueous	warm sat.	40	r
	warm sat.	60	r
Hydrosulfite, aqueous	up to 10	40	r
	up to 10	60	r
Hydroxylamine sulfate, aqueous	up to 12	35	r
Lactic acid, aqueous	up to 10	40	r
	up to 10	60	r
	90	60	r

# CHEMICAL RESISTANCE CHART

CHEMICAL	Concentr. %	Temp. °C	Silencio PP
Lead acetate, aqueous	warm sat.	50	r
Butylene, liquid	100	20	-
Butylphenol	100	20	r
Butynediol	up to 100	40	-
Butyric acid, aqueous	20	20	r
	concentr.	20	r
Calcium chloride, aqueous	diluted	40	r
	diluted	60	r
	saturated	60 r	
Calcium nitrate, aqueous	50	40	r
Carbolinum, aqueous	usage conc.	20	-
Carbon dioxide, aqueous under 8 atmospheric pressures	saturated	20	-
Carbon dioxide, dry	100	60	r
Carbon dioxide, moist	any	40	r
	any	60	r
Carbon disulfide	100	20	cr
Carbon tetrachloride, technical	100	20	nr
Caustic potash solution, aqueous			
	up to 40	40	r
	up to 40	60	r
	50/60	60	r
Caustic soda, aqueous	up to 40	40	r
	up to 40	60	r
	50/60	60	r
Chloramine, aqueous	diluted	20	-
Chloric acid, aqueous	1	40	-
	1	60	-
	10	40	-
	10	60	-
	20	40	-
	20	60	-
Chlorine water	saturated	20	cr
Chlorine, gaseous, dry	100	20	nr
Chlorine, gaseous, moist	0,5	20	nr
	1	20	nr
	5	20	nr
Chlormethyl	100	20	-
Chloroacetic acid (mono)	100	40	r
	100	60	-
Chloroacetic acid (mono) aqueous	85	20	r
Chlorosulfonic acid	100	20	nr
Chromic acid, aqueous	up to 50	40	-
	up to 50	60	cr
Chromic acid/Sulphuric acid/Water	50/15/35	40	nr
	50/15/35	60	nr
	diluted	40	r

CHEMICAL	Concentr. %	Temp. °C	Silencio PP
	diluted	60	r
	saturated	60	r
Lead tetraethyl	100	20	r
Magnesium chloride, aqueous	diluted	40	r
	diluted	60	r
	saturated	60 r	
Magnesium sulfate, aqueous	diluted	40	r
	diluted	60	r
	saturated	60	r
Maleic acid, aqueous	saturated	40	r
	saturated	60	r
	35	40 r	
Malic acid, aqueous	1	20	r
Mersol D	custom. conc	40.	-
Methanol	100	40	r
	100	60	r
Methyl amine	32	20	r
Methylene chloride	100	20	nr
Milk	com. avail.	20	r
Mixed acid (Sulfuric acid/Nitric acid/Water)	48/49/3	20	nr
	48/49/3	40	nr
	50/50/0	20	nr
	50/50/0	40	nr
	10/20/70	50	cr
	10/87/3	20	nr
	50/31/19	30	nr
Molasses	custom. conc	20	r
	custom. conc	60	r
Molasses wort	custom. conc	60	r
Mowilith D	com. avail.	20	-
Nekal, BX, aqueous	diluted	40	-
	diluted	60	-
Nickel sulfate, aqueous	diluted	40	r
	diluted	60	r
	saturated	60 r	
Nicotine compounds, aqueous	usage conc.	20	-
Nicotine, aqueous	usage conc.	20	-
Nitric acid, aqueous	up to 30	50	r
	30/50	50	nr
	98	20	nr
	98	60	nr
Nitrous gasses	concentr.	20	r
	concentr.	60	-
Oils and greases	com. avail.	60	cr
Oleic acid	com. avail.	60	cr
Oleum vapour	lower	20	cr
	higher	20	nr
Oxalic acid, aqueous	diluted	40	r
	diluted	60	r

# CHEMICAL RESISTANCE CHART

CHEMICAL	Concentr, %	Temp. °C	Silencio PP
	saturated	60	r
Oxygen	any	60	-
Ozone	100	20	cr
	10	30	r
Palm kernel oil acid	100	60	-
Paraffin emulsions	com. avail.	20	-
	com. avail.	40	-
Perchloric acid, aqueous	up to 10	40	r
	up to 10	60	r
	saturated	60	-
Petrol	100	60	nr
Petrol-benzene mixture	80/20	20	cr
Phenol, aqueous	up to 90	45	r
	1	20	-
Phenylhydrazine	100	20	cr
	100	60	-
Phenylhydrazine hydrochloride, aqueous	saturated	20	-
	saturated	60	-
Phosgene, aqueous	100	20	nr
Phosgene, gaseous	100	20	cr
	100	60	cr
Phosphoric acid, aqueous	up to 30	40	r
	up to 30	60	r
	40	60	r
	80	20 r	
	80	60 r	
Phosphorous pentoxide	100	20	r
Phosphorous trichloride	100	20	r
Photographic developers	com. avail.	40	r
Photographic emulsions	any	40	-
Photographic fixers	com. avail.	40	r
Picric acid, aqueous	1	20	r
Potash, aqueous	saturated	40	-
Potassium borate, aqueous	1	40	r
	1	60	r
Potassium bromate, aqueous	up to 10	40	r
	up to 10	60	r
Potassium bromide, aqueous	diluted	40	r
	diluted	60	r
	saturated	60	r
Potassium chlorate, aqueous	1	40	r
	1	60	r
Potassium chloride, aqueous	diluted	40	r
	diluted	60	r
	saturated	60	r
Potassium chromate, aqueous	40	20	r
Potassium cyanide, aqueous	up to 10	40	r
	up to 10	60	r

CHEMICAL	Concentr, %	Temp. °C	Silencio PP
	saturated	60	r
Potassium dichromate, aqueous	40	20	r
Potassium ferrocyanide	diluted	40	r
Potassium ferrocyanide, aqueous	diluted	60	r
	saturated	60	r
Potassium nitrate, aqueous	diluted	40	r
	diluted	60	r
	saturated	60	r
Potassium permanganate, aqueous	up to 6	20	r
	up to 6	40	r
	up to 6	60	r
	up to 18	40	-
Potassium persulfate, aqueous	diluted	40	r
	diluted	60	r
	saturated	40 r	
	saturated	60 r	
Propane, gaseous	100	20	-
Propane, liquid	100	20	-
Propargyl alcohol, aqueous	7	60	r
Pure acetic acid	100	20	r
	100	40	r
Ramasite	com. avail.	20	-
	com. avail.	40	-
Roaster gases, dry	any	60	r
Seawater	-	40	r
	-	60	r
Silicic acid, aqueous	any	60	r
Silver nitrate, aqueous	up to 8	40	r
	up to 8	60	r
Soap solution, aqueous	concentrated	20	r
	concentrated	60	r
Soda, aqueous	diluted	40	r
	diluted	60	r
	saturated	60	r
Sodium benzoate, aqueous	up to 10	40	r
	up to 10	60	r
	36	60	r
Sodium chlorate, aqueous	up to 10	40	r
	up to 10	60	r
	saturated	60	r
Sodium chlorite, aqueous	50	20	r
	diluted	60	nr
Sodium hydrosulfate, aqueous	diluted	40	r
	diluted	60	r
	saturated	60	r
Sodium hypochlorite, aqueous	diluted	20	r
Sodium sulfide, aqueous	diluted	40	r

# CHEMICAL RESISTANCE CHART

CHEMICAL	Concentr, %	Temp. °C	Silencio PP
	diluted	60	r
	saturated	60	r
Spirits	com. avail.	20	r
Starch syrup	custom. conc	60	r
Starch, aqueous	any	40	r
	any	60	r
Stearic acid	100	60	cr
Sulphur dioxide, aqueous under 8 atmospheric pressures	saturated	20	-
Sulphur dioxide, liquid	100	-10	-
	100	20	r
	100	60	r
Sulphur dioxide, moist and aqueous any	40	r	
	50	50	r
	any	60	r
Sulphur dioxide, dry	any	60	r
Sulphuric acid, aqueous	up to 40	40	r
	up to 40	60	r
	70	20	r
	70	60	cr
	80-90	40	cr
	96	20	r
	96	60	nr
Table salt, aqueous	diluted	40	r
	diluted	60	r
	saturated	60	r
Tallow	100	20	r
	100	60	r
Tanigan extra A, aqueous	any	20	-
Tanigan extra B, aqueous	any	20	-
Tanigan extra D, aqueous	saturated	40	-
	saturated	60	-
Tanigan F, aqueous	saturated	60	-
Tanigan U, aqueous	saturated	40	-
	saturated	60	-
Tanning extracts, cellul.	common	20	r

CHEMICAL	Concentr, %	Temp. °C	Silencio PP
Tanning extracts, natural	common	20	r
Tartaric acid, aqueous	up to 10	40	r
	up to 10	60	r
	saturated	60	r
Thionyl chloride	100	20	nr
Tin (II) chloride, aqueous	diluted	40	r
	diluted	60	r
	saturated	60	r
Toluene	100	20	nr
Trichloroethylene	100	20	nr
Triethanolamine	100	20	r
Trilone	com. avail.	60	-
Trimethylolpropane, aqueous	up to 10	40	-
	up to 10	60	-
	com. avail.	40	r
	com. avail.	60	r
Urea, aqueous	up to 10	40	r
	up to 10	60	r
	33	60	r
Urine	normal	40	r
	normal	60	r
Vinegar (wine vinegar)	com. avail.	40	r
	com. avail.	50	r
	com. avail.	60	r
Vinyl acetate	100	20	r
Water	100		r
	100		r
Wax alcohol	100	60	cr
Wine, red and white	com. avail.	20	r
Xylene	100	20	nr
Yeast wort	custom. con	40	r
	custom. con	60	r
Zinc chloride, aqueous	diluted	40	r
	diluted	60	r
	saturated	60	r
Zinc sulphate, aqueous	diluted	40	r
	diluted	60	r
	saturated	60	r

# CLIENT LIST

## HOSPITALS

- Aim's Hospital
  - Ahmedabad
- Cancer Hospital
  - Ahmedabad
- STAR Hospital
  - Baroda
- Alexis Multi-Speciality Hospital
  - Nagpur
- Chandigarh Health Care
  - Sector 69, Mohali, Punjab
- Kulshan Hospital
  - Srinagar
- Yashodha Hospital
  - Hyderabad
- Christian Medical College
  - Vellore
- Zydus Hospital
  - Ahmedabad
- Kokilaben Hospital
  - Mumbai
- Lilavati Hospital
  - Mumbai
- Super Speciality Hospital For Govt. Medical College
  - Indore
- Amrita Hospital
  - Faridabad
- AIIMS
  - Bhatinda
- Midland Hospital
  - Lucknow
- Globe Medicare
  - Lucknow
- Welsun Medicity Hospital
  - Lucknow
- Naruvi Hospital
  - Vellore
- MVR Cancer Centre
  - Calicut
- District General Hospital
  - Cochine



## HOTELS

- Fame Hotels
  - Berhampur, West Bengal
- Hotel Tip Top International
  - Pune
- Palm Grove Beach Hotels Pvt. Ltd.
  - Pune
- Hotel Fidalgo
  - Pune
- Ritz Resort
  - Lucknow
- BGR Hotel
  - Banjerahills, Hyderabad
- Hotel Rama International
  - Aurangabad
- Hotel Royal Park
  - Delhi
- Hotel Bramhani
  - Jajpur Road, Jajpur
- Hotel World
  - Janpath, Bhubaneswar
- Hotel Hyatt
  - Lucknow
- Hotel Hyatt
  - Kochi
- The Leela Gandhinagar
  - Gandhinagar
- Cama Hotel
  - Ahmedabad
- Radisson Blue MIDC
  - Mumbai
- Golconda resorts
  - Hyderabad
- Sheraton
  - Kathmandu
- Best Western Hotel
  - Mohali
- West Inn
  - Rishikesh
- The Fern
  - Jaipur
- Hotel Total Fresh Food
  - Lucknow
- Ramada Hotel & Resorts
  - Trivandrum
- Fogg Resorts
  - Munnar
- Foushia Resorts
  - Munnar
- Paraizo The Club
  - Surat



## OFFICE BUILDINGS

- AB Jewelers
  - Ahmedabad
- Airport Authority
  - Delhi
- Laboratory Building of Odisha State Pollution Board
  - Bhuvneshwar (Orissa)
- BE Chemical & Pharmaceuticals
  - Hyderabad
- Corporate Office
  - Nyati - Pune
- Dhunseri I.T. Park
  - Kolkatta
- Gymkhana Club
  - Ahmedabad
- World Trade Center
  - Greater Noida
- Amway
  - Madurai
- Mercedes Benz
  - Pune
- S&P Infocity
  - Perungudi, Chennai
- Surat Diamond Bourse
  - Surat
- Bombay House
  - Mumbai
- Facebook Inc
  - Bangalore
- Pallacia
  - Jaipur
- Jaipur Airport
  - Jaipur
- Hatsun Dairy Products
  - Solahpur
- Lulu Conventional Centre
  - Cochin
- Cochin International Airport
  - Cochin



## RESIDENTIAL PROJECTS

- Manhattan
  - Pune
- Sri Avani
  - Kolkatta
- Lodha Primero
  - Mumbai
- Vini Elegant
  - Borivali(W), Mumbai
- Bay View Project
  - Mumbai
- 24K Allura, Margosa
  - Pune
- My Homes
  - Hyderabad
- Akriti Shantiniketan
  - Noida
- Pride Group
  - Pune
- Viva Swaraj
  - Pune
- Urbana
  - Kolkata
- Omkar Alta Monte
  - Mumbai
- Price Town Kumar B1 Properties
  - Bangalore
- Siddha Group
  - Kolkata
- Kukreja Builders
  - Mumbai
- North Eye
  - Noida
- Amanora
  - Pune
- Empire Square
  - Pune
- South India Shelters
  - Chennai
- One 49
  - Ahmedabad
- Paarijat Eclat
  - Ahmedabad
- The Seventy
  - Ahmedabad
- The Bunglows
  - Ahmedabad
- Shangri-la
  - Ahmedabad
- Altamonte
  - Mumbai
- Lokhandwala Minerva
  - Mumbai
- Daria Mahal Society
  - Mumbai
- Panchratna Heights
  - Ranchi
- Exotica
  - Ranchi
- Iscon Temple
  - Visakhapatnam
- Urbana
  - Kolkata
- RSH Signature
  - Kolkata
- Rare Earth
  - Kolkata
- PSAurus
  - Kolkata
- The Reserve
  - Kolkata
- PS Anassa
  - Kolkata
- PS Srijan Ozone PH-II
  - Kolkata
- Radha Swami Santsang Beas
  - Jaipur



## EDUCATIONAL INSTITUTES

- Rajasthan Vidyalay
  - Andheri (W), Mumbai
- Holy angel School
  - Rajpura, Punjab
- Delhi Public School
  - Bangalore
- Sereum Institute
  - Pune
- Nri Hostel
  - Pune
- Laboratory Building of State Pollution Control Board
  - Bhubaneswar
- Akshaya Patra Foundation
  - Phul Nakhra, Cuttack



## SHOPPING MALLS

- E Square Mall
  - Mumbai
- Hemadurga Multiplex
  - Hyderabad
- Casa Imperia
  - Pune
- Sairanga Theatre
  - Miyapur, Hyderabad
- Central Mall
  - Ranchi
- City Centre Patna
  - Patna











*A consumer validated Superbrand in piping category for consecutive 4 years*

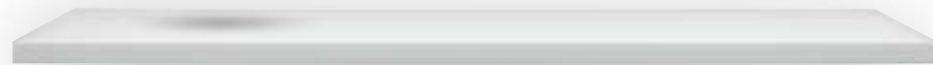

*India's Most Trusted Pipe Brand based on TRA's Brand Trust Report for the 5<sup>th</sup> time*

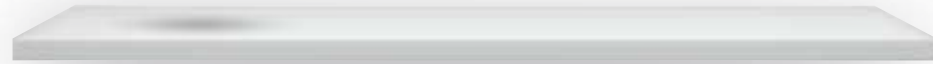

**Power of Desire**



*India's Most Desired Brand based on TRA's Brand Trust Report 2022*

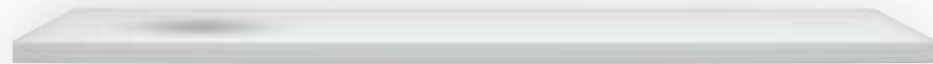

CIN NO: L25200GJ1996PLC029134

Registered & Corporate Office: Astral Limited

207/1, 'Astral House', B/h Rajpath Club, Off S. G. Highway, Ahmedabad - 380059.

Ph: +91-79 6621 2000 | Fax: +91-79 6621 2121 | E-mail: info@astralltd.com | Website: www.astralltd.com

For Export Inquiries: export@astralltd.com



**ASTRAL TOLL FREE 1800 233 7957**

Please get in touch with us between 10 AM to 6 PM between Monday to Friday and the last Saturday of the month. We will remain closed on Public Holidays.

SC: PR07000042  
ASL/PCN/003  
REV:07/23